

BD8400W Air-dryer



User's Guide





WARNING:

This product can expose you to chemicals including Lead, which is known to the State of California to cause cancer/birth defects or other reproductive harm. For more information go to www.P65Warnings.ca.gov

1. Welcome & Congratulations

Congratulations on your purchase of a new RFS BD8400W Air-dryer! We here at RFS are very proud of our products and we are committed to providing you with the best value and service possible.

We are sure that you will be satisfied with your new air-dryer and would like to thank you for choosing RFS for your air-dryer requirements. We also hope that you will continue to choose us for your future air pressure and related product purchases.

For information about this and other RFS products, please visit us on the web at:

www.rfsworld.com

2. Introduction

PLEASE READ THIS USER'S GUIDE THOROUGHLY AND SAVE FOR FUTURE REFERENCE.

This User's Guide is provided for the benefit of our customers and contains information and direction specific to the RFS BD8400W Air-dryer. It will cover topics including: safety, specifications, installation, registration, operation, testing, maintenance, replacement parts, service, and troubleshooting issues. Observation and compliance with this User's Guide will ensure the maximum life and efficiency of your air-dryer.

This User's Guide should be read thoroughly prior to installing, operating, or servicing the air-dryer in order to become familiar with the recommended procedures. This will minimize the possibility of personal injury or damage to the unit due to improper operation or handling.

3. Table of Contents

1. Welcome & Congratulations	3	8.13 Setting the Static Pressure.....	55
2. Introduction	3	8.14 Setting the Outlet Pressure.....	56
3. Table of Contents.....	4	8.15 Engaging the Boost Transformer	57
4. Safety & Warning Information.....	6	8.16 Connecting via Web Browser	57
5. Overview & Specifications.....	8	8.17 Using the Status Screen	59
5.1 Product Description	8	8.18 Using the Setup Screen	60
5.2 Key Features	9	8.19 Using the Event/Alarm Screen.....	62
5.3 Technical Specifications.....	9	8.20 Using the Firmware Screen.....	63
5.4 Dryer Function Overview	10	8.21 Connecting via SNMP	64
6. Installing Your Dryer.....	11	9. Testing Your Dryer	65
6.1 Safety & Warning Information	11	9.1 Safety & Warning Information	65
6.2 Before You Begin.....	12	9.2 Measuring Compressor Amp Draw	66
6.3 Included Contents	13	9.3 Measuring Voltage to Compressor	67
6.4 Required Tools and Materials.....	13	9.4 Measuring Incoming Voltage	68
6.5 Installation Steps.....	13	9.5 Measuring Voltages at Solid State Relay	
6.6 Installation Checklist	23	69
7. Registering Your Dryer.....	24	9.6 Testing Consistent Heatless Dryer	
8. Operating Your Dryer	25	Cycling.....	70
8.1 Safety & Warning Information	25	9.7 Testing Unloader Valve	71
8.2 Connecting Air Lines to the Dryer	26	9.8 Measuring Heatless Dryer Solenoid	
8.3 Powering the Dryer ON & OFF.....	26	Voltage.....	73
8.4 Using the Front Panel Display	27	9.9 Testing Precooler Fans.....	74
8.5 Identifying Dryer Alarms	30	9.10 Testing Safety Relief Valve.....	74
8.6 Accessing the Setup Menu.....	35	9.11 Testing Compressor ON/OFF Cycling	75
8.7 Using the System Setup Menu.....	36	9.12 Testing Compressor Excessive Run	
8.8 Using the Alarm Setup Menu	42	Time Alarms	76
8.9 Using the Network Setup Menu.....	48	9.13 Testing Humidity Alarm and System	
8.10 Opening Panels	54	Shutdown	77
8.11 Depressurizing the Dryer	54	9.14 Testing High Outlet Pressure Alarm....	79
8.12 Setting the System Pressure.....	55	9.15 Testing Low Outlet Pressure Alarm....	80
		9.16 Testing Air Fittings & Hoses for Leaks	
		82
		10. Maintaining Your Dryer	83
		10.1 Safety & Warning Information	83

10.2 Six Month Maintenance.....	85	13.12 Can't Create a High Humidity Alarm / Shutdown	101
10.3 8,000 & 16,000 Hour Maintenance	86	13.13 Compressor Doesn't Operate.....	101
11. Replacement Parts & Accessories	87	13.14 Compressor Won't Build Pressure... ..	102
11.1 Top Section Parts.....	87	13.15 Compressor Excessive AMP Draw..	102
11.2 Middle Section Parts.....	88	13.16 High Compressor Temperature.....	103
11.3 Heatless Dryer Assembly Parts.....	89	13.17 Compressor Excessive Run Time Alarm	103
11.4 Lower Section Parts.....	90	13.18 Can't Create a Compressor Excessive Run Time Alarm	104
11.5 Frame Section Parts	91	13.19 Compressor Rapid ON/OFF Cycling	104
11.6 Accessories for Your Dryer	92	13.20 Inconsistent Heatless Dryer Cycling	104
11.7 Ordering Parts from RFS	93	13.21 Contacting RFS Technical Support..	105
12. Service & Repair.....	94	14. Appendix	106
12.1 Services Offered	94	14.1 Wiring Diagram	106
12.2 Initiating a Service Transaction	94	14.2 Set Point Limits and Defaults	107
13. Troubleshooting Your Dryer	95	15. Limited Warranty Agreement.....	109
13.1 Before You Call RFS.....	95	Registration Reminder	109
13.2 Safety & Warning Information.....	95	16. Contacting RFS.....	110
13.3 Air-dryer Won't Power ON.....	97	16.1 General / Sales	110
13.4 Display Screen Not Functioning.....	97	16.2 Service	110
13.5 High Outlet Pressure Alarm.....	97	16.3 Technical Support.....	110
13.6 Can't Create a High Pressure Alarm... ..	98	17. Notes.....	111
13.7 Low Outlet Pressure Alarm	98		
13.8 Can't Create a Low Pressure Alarm	99		
13.9 High Flow Rate Alarm.....	99		
13.10 High Cabinet Temperature Alarm	99		
13.11 High Humidity	100		

4. Safety & Warning Information

This section contains general information about safety and warning points to consider and adhere to during installation, operation, and maintenance of your air-dryer. **PLEASE READ THIS SECTION BEFORE PERFORMING ANY OPERATION OR PROCEDURE ON YOUR AIR-DRYER.**

Additional warnings specific to an operation or procedure will also be presented throughout the following sections. These will include the  symbol as well as a label of “**WARNING!**”, “**CAUTION!**”, or “**IMPORTANT!**”. Please be sure to pay close attention for these warnings and read them as you encounter them.



WARNING!

For your safety, all the information in this User's Guide must be followed to minimize the risk of electrical shock and prevent property damage or personal injury.



WARNING!

Extreme care should be exercised to avoid contact with live electrical circuits. Many procedures performed during installation, operation, testing, and maintenance of this air-dryer require the equipment to be running, creating a situation for potential electrical shock. It is highly recommended that you remove all jewelry before performing any procedures.



WARNING!

Internal surfaces may be hot. Use care when contacting internal components as there is a potential for some of these components to become hot when in operation or standby.

**WARNING!**

High Noise. PUREGAS air-dryers are meant to be installed in an unattended area.

**CAUTION!**

Proper Installation & Maintenance as outlined in this User's Guide is extremely important to ensure the reliability and longevity of the equipment as well as prevent damage or personal injury.

**CAUTION!**

Depressurizing the air-dryer may be necessary before performing certain procedures. **NEVER** remove pressure sensing tubes from the Control Board without depressurizing the air-dryer first, or **damage to the Control Board will occur.**

**CAUTION!**

Incoming power to dryer must be 190 - 230 VAC, 1 Phase, 50 / 60 Hz with minimum 20 amp service (3-wire, nub-out receptacle) with a 20 amp circuit breaker. If hard-wiring directly, minimum of 12 AWG wire must be used with an External Surge Protection Device (SPD).

**IMPORTANT!**

Performing routine maintenance as outlined in the *Maintaining Your Dryer* section will ensure optimal performance over the lifecycle of your air-dryer.

**IMPORTANT!**

Performing procedures not described in this User's Guide or installing components not supplied by PUREGAS is **NOT RECOMMENDED AND MAY VOID THE WARRANTY.**

**CAUTION!**

This Air-dryer does not contain an internal Surge Protection Device (SPD). An SPD is required and must be supplied by the user.

**CAUTION!**

Observe precautions for handling **Electrostatic Sensitive Devices**.

**IMPORTANT!**

Installation of RFS air-dryers are intended for network telecommunication facilities (non-customer premises) only.

5. Overview & Specifications

5.1 Product Description

The BD8400W Air-dryer from RFS is designed to intake wet ambient air and remove the moisture for delivery to applications requiring a constant, on-demand source of dry, pressurized air. This process is fully automatic and will remain consistent with minimal required periodic maintenance. This dryer is designed specifically for indoor use.

The BD8400W Air-dryer employs dual redundant systems that can be run independently, interchangeably, or simultaneously depending on your pressurized air requirement. Other features of the BD8400W Air-dryer include a fully digital operating platform offering the most accurate readings of dryer variables, removable access panels allowing easier access for adjustment and maintenance, and ultra quiet compressors with an industry leading maintenance interval of 8,000 hours.

5.2 Key Features

- LCD display of all operating parameters
- Precise humidity sensing within $\pm 0.1\%$ RH
- Redundant system for internal backup from one system to the other
- Removable compressor tray for easy maintenance
- Oil-less compressors with 8,000-hour maintenance interval
- Remote alarm reset capabilities & access via HTML interface
- SNMP communications capable

5.3 Technical Specifications

Output Capacity	Normal: 6,500 SCFD both systems, 3,250 SCFD single system Maximum: 8,400 SCFD both systems, 4,200 SCFD single system
Power Requirements	190 -230 VAC, 1 Phase, 50 / 60 Hz
Electrical Characteristics	Running Amps: 15 (20 Amp service recommended)
Outlet Pressure Range	0 – 15 PSI (adjustable)
Outlet Air Humidity	Less than 2% RH
Compressor Type	2-cylinder, 3/4 HP, oil-less type compressor
Drying Method	Heatless Desiccant
Operating Temperature Range	40° to 85° F (5° to 30° C) Optimal
Noise Level	78.8 dBA
Heat Dissipation	6,000 BTU/hr
Alarms	Standard alarms – complete readings of all critical measurement points, individual alarm indication display
Outlet Connections	Pressure Outlet: 1/2" NPT Female
Dimensions	21" D x 25.25" W x 49" H (53.3 cm x 64.1 cm x 124.5 cm)
Net / Shipping Weight	265 lbs (120 kgs) / 318 lbs (144 kgs)

5.4 Dryer Function Overview

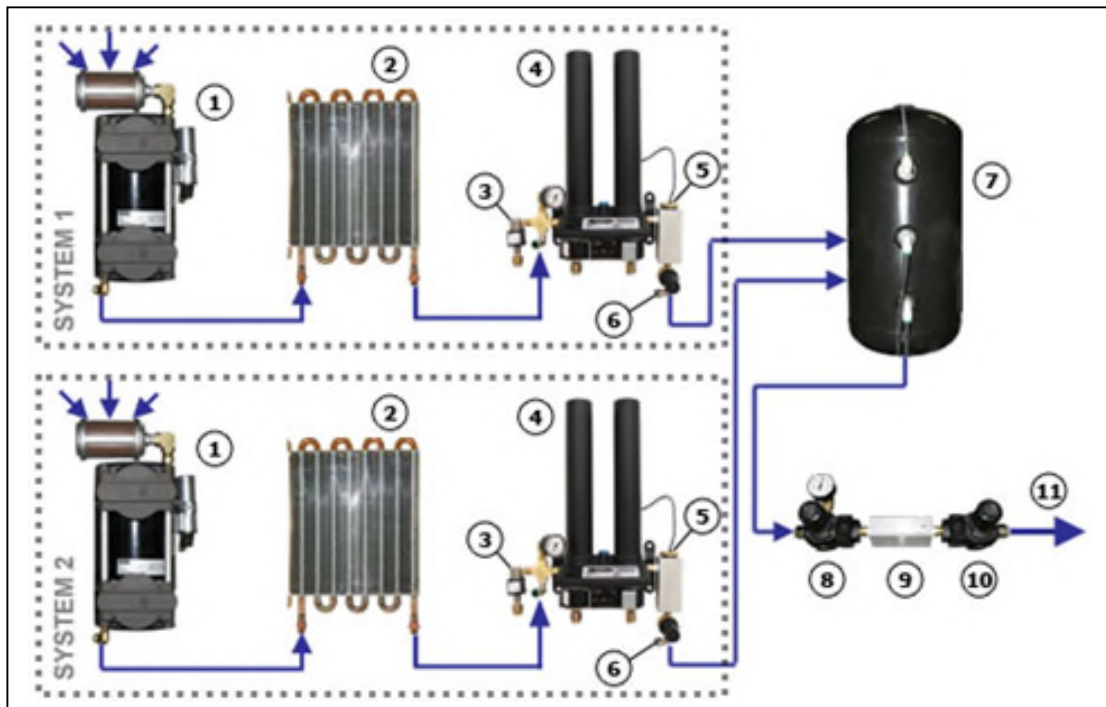

#	Component	Description
1	Compressor	Compresses drawn in ambient air.
2	Precooler	Cools compressed air prior to drying function.
3	Unloader Valve	Relieves excess compressor head pressure.
4	Heatless Dryer	Removes moisture from compressed air.
5	Humidity Sensor	Measures the humidity of the compressed air.
6	Capacity Control Valve	Regulates system pressure and prevents air from bleeding back through the heatless dryer.
7	Air Tank	Stores dry compressed air.
8	Static Pressure Regulator	Regulates the static pressure (17 PSI). Maintains constant pressure on the flow block for accurate flow measuring.
9	Flow Block	Measures the flow of compressed air.
10	Outlet Pressure Regulator	Regulates the outlet pressure.
11	Pressure Outlet	Outputs the pressure set by the Outlet Pressure Regulator.

6. Installing Your Dryer

6.1 Safety & Warning Information



WARNING!

Internal surfaces may be hot. Use care when coming into contact with internal components as there is a potential for some of these components to become hot when in operation or standby.



WARNING!

Extreme care should be exercised to avoid contact with live electrical circuits. Many procedures performed during installation, operation, testing, and maintenance of this air-dryer require the equipment to be running, creating a situation for potential electrical shock. It is highly recommended that you remove all jewelry before performing any procedures.



WARNING!

High Noise. Air-dryers are meant to be installed in an unattended area.



CAUTION!

Proper Installation & Maintenance as outlined in this User's Guide is extremely important to ensure the reliability and longevity of the equipment as well as prevent damage or personal injury.



CAUTION!

This Air-dryer does not contain an internal Surge Protection Device (SPD). An SPD is required and must be supplied by the user.

**IMPORTANT!**

Performing procedures not described in this User's Guide or installing components not supplied by PUREGAS is NOT RECOMMENDED AND MAY VOID THE WARRANTY.

**IMPORTANT!**

Installation of PUREGAS air-dryers are intended for network telecommunication facilities (non-customer premises) only.

6.2 Before You Begin

6.2.1 Carefully inspect the unit, including the shipping box as well as the air-dryer, for ANY DAMAGE CAUSED BY SHIPPING. If any shipping damage is detected, it is important to file a claim with the shipping company prior to continuing the installation procedures.

6.2.2 Read the entire *Installing Your Dryer* section to familiarize yourself with the components and procedures before performing the air-dryer installation.

6.2.3 Verify the installation location of the air-dryer:

6.2.3.1 Well ventilated and free from abrasive dust or chemicals.

6.2.3.2 Ambient temperature is between 40° and 85° F (optimal).

NOTE: Higher temperatures will decrease component lifespan.

6.2.3.3 Meets the following power requirements:

- 190 -230 VAC, 1 Phase, 50 / 60 Hz
- Minimum 20 amp service circuit breaker
- Outlet compatible with a HBL9965C plug
- If hard-wiring directly, minimum of 12 AWG wire must be used

6.2.4 Notify the alarm center of the installation and potential for alarms during the process (as necessary).

6.3 Included Contents

- (1) BD8400W Air-dryer
- (1) Installation Guide (not shown)

Package located inside the dryer:

- (1) User's Guide (not shown)

- (2) Purge Mufflers



6.4 Required Tools and Materials

- Large adjustable wrench
- Medium adjustable wrench
- 7/16" wrench
- Band cutters or snips
- Lifting Straps
- Pipe dope or pipe thread tape
- Cup of soapy water
- 1-inch paint brush (recommended)

6.5 Installation Steps

- 6.5.1 Remove all shipping materials.

NOTE: If ANY SHIPPING DAMAGE is detected, file a claim with the shipping company prior to continuing the installation procedures.

- 6.5.2 Place the dryer at the operating location using lifting straps.

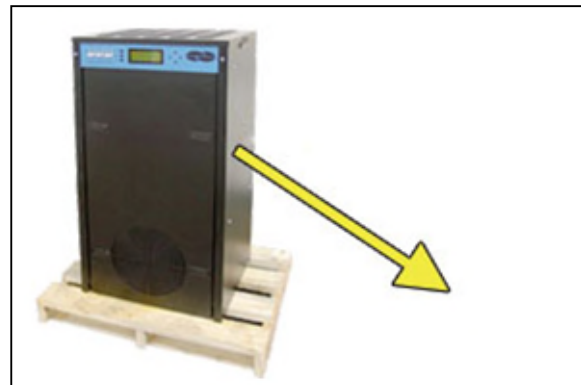

6.5.3 Remove the front panel.

The front panel and top cover are equipped with locking latches if a higher level of security is required.

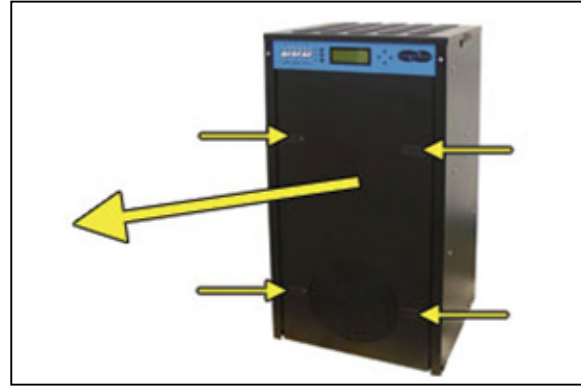
**6.5.4** Check for loose parts, hoses, or wiring.

NOTE: If ANY SHIPPING DAMAGE is detected, file a claim with the shipping company prior to continuing the installation procedures.

**6.5.5** Remove the shipping block from under the compressor plates.

Discard block and bolts.

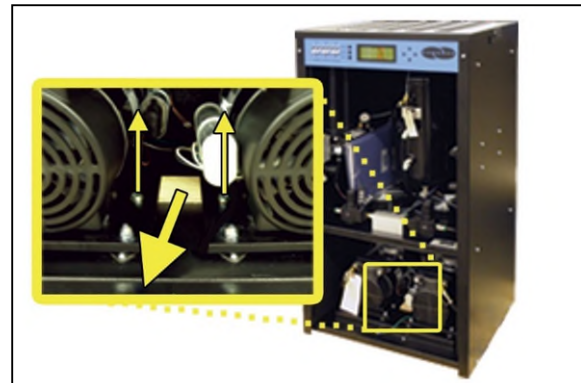

- 6.5.6** Remove the ship-loose contents package.

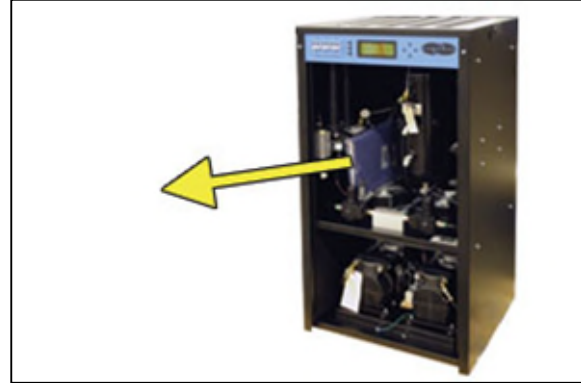

On BACK of dryer:

- 6.5.7** Verify that the red orifice plug is still installed where shown.

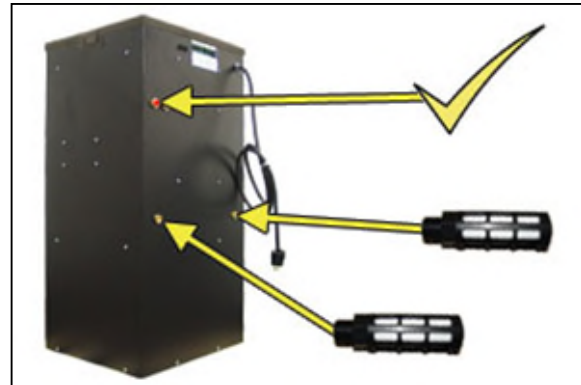

- 6.5.8** Install the two (2) purge mufflers (shipped loose).

- 6.5.9** Verify that the dryer is powered **OFF**.

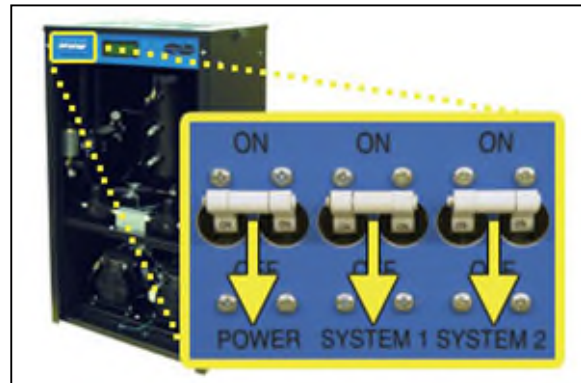

- 6.5.10** Plug the power cord into a 190 - 230 VAC, 1 phase, 50 / 60 Hz power outlet. (HBL9965C Compatible and NRTL approved plug)

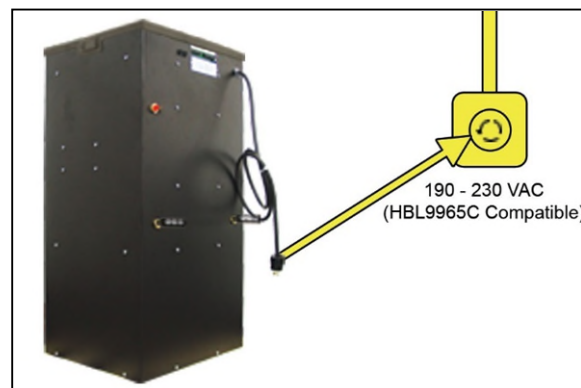

6.5.11 Remove the Top Cover from the dryer.

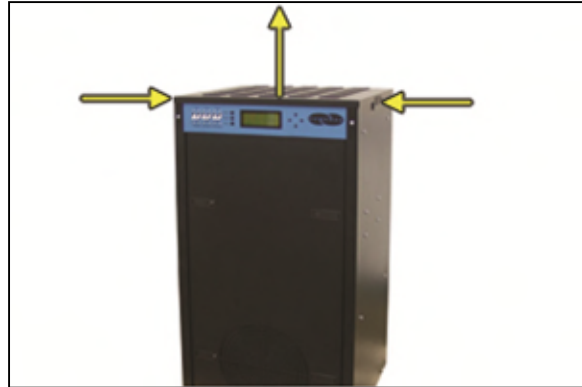

6.5.12 Verify incoming voltage measurement:

6.5.12.1 Locate the Main POWER Circuit Breaker.



6.5.12.2 Use a Voltmeter to measure the voltage by placing the probes between the Circuit Breaker and terminal insulation so that they touch the metal contacts.

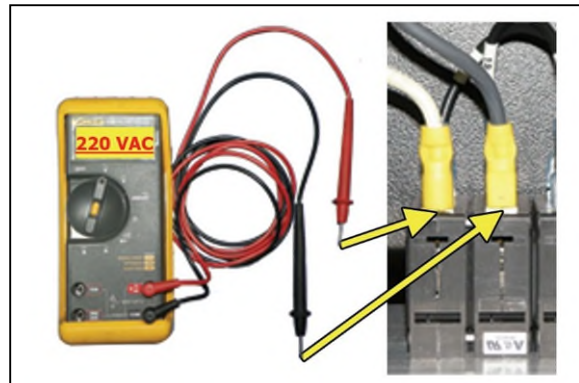

If the voltage measures between 210 – 230 VAC, skip to step 6.5.14 .

If the voltage measures less than 210 VAC, continue to the next steps to engage the Boost Transformer.

6.5.13 Engage the Boost Transformer:

6.5.13.1 Unplug the power cord from the power outlet.

6.5.13.2 Locate the Main Power Lead quick disconnects in the top section of the dryer.

6.5.13.3 Unplug the Main Power Lead quick disconnects.

6.5.13.4 Plug both Boost Transformer Lead connectors into the Main Power Lead connectors.

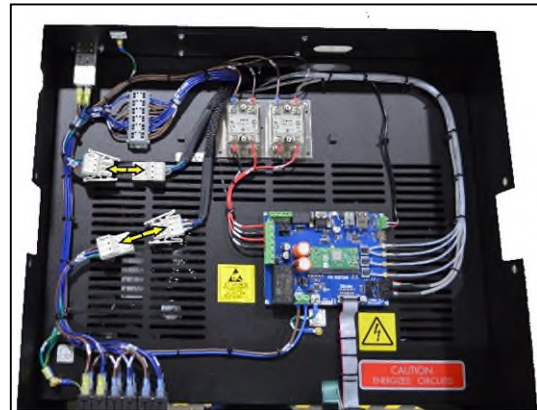
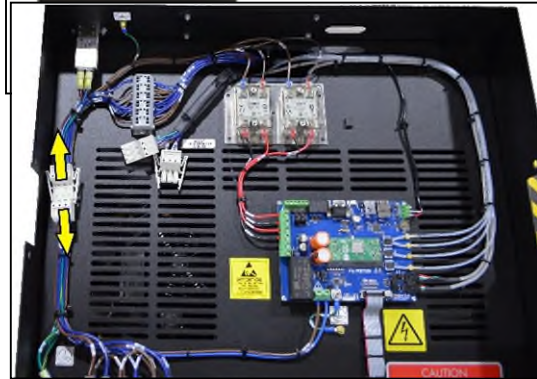
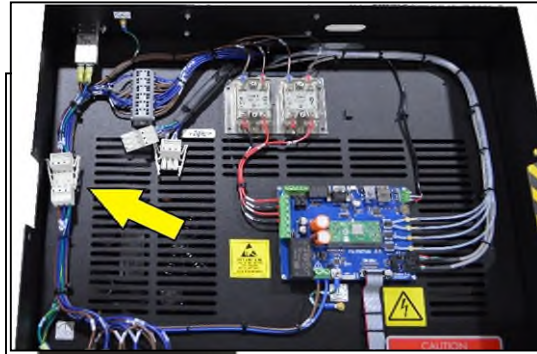

The incoming power wiring should now look like this:

6.5.13.5 Plug the power cord back into the power outlet.

6.5.14 Reinstall the Top Cover back onto the dryer.

6.5.15 Turn the dryer power **ON**.

NOTE: Both system compressors and heatless dryers will start, creating air flow through the red outlet pressure orifice.

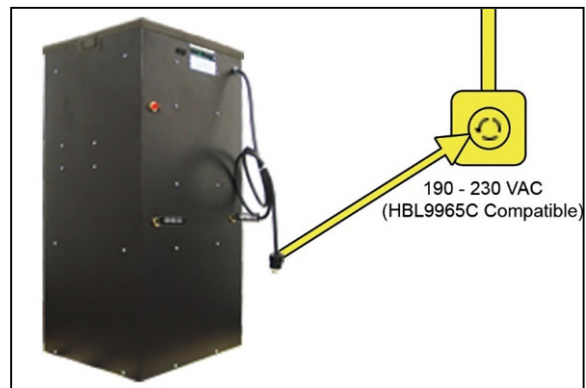

6.5.16 Set the System Pressures:
System 1 & System 2 are adjusted and set independently. Perform the following steps for System 1 (left) and then repeat the steps for System 2 (right).

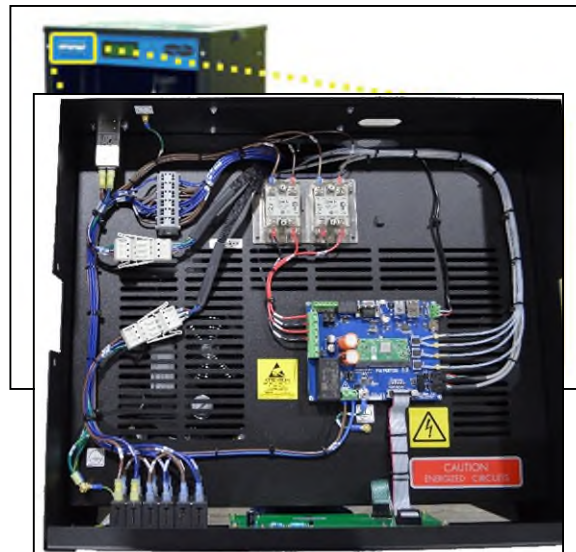

With Compressor running:

- 6.5.16.1** Pull the Capacity Control Valve knob out.

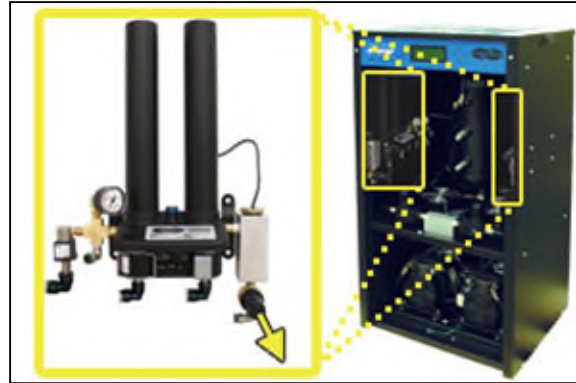

- 6.5.16.2** Turn the knob until the reading on the pressure gauge is **50 PSI**.



- 6.5.16.3** Push the knob in to lock.

- 6.5.17** Let the dryer run until the Humidity drops under 2% on both System 1 and System 2 (may take up to 15 minutes).

```

SYSTEM 1 : ONLINE
HUMIDITY-  1.9%
DUTY CYCLE- 29%
←→SEL  ↑SETUP  #HOLD
  
```

NOTE: Press **RESET** if either System goes into **SHUTDOWN**.

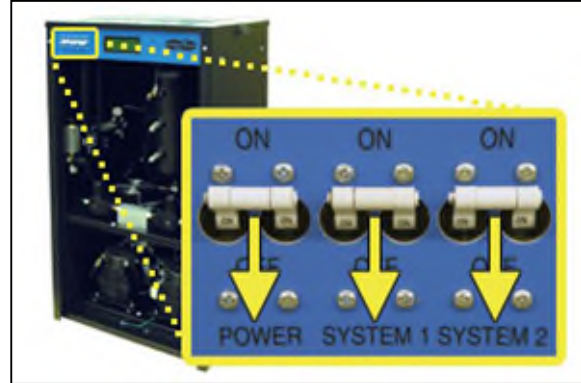
6.5.18 Turn the dryer **OFF**.**6.5.19** Connect the air supply line to the dryer.

⚠ CAUTION: Be careful when removing outlet plug. System may be pressurized.

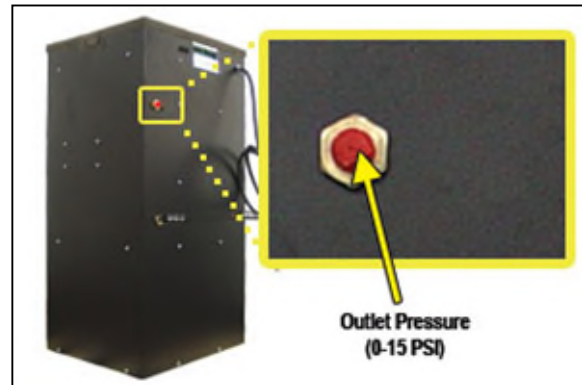

RFS recommends using Installation Kit P011752 to connect your dryer to the air supply line (See section 11.6 for detail).

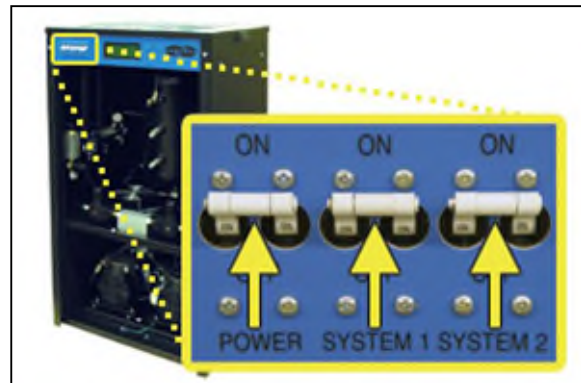
6.5.20 Turn the dryer **ON**.

6.5.21 Set the Static Pressure:

6.5.21.1 Pull Static Pressure Regulator knob out.

6.5.21.2 Turn knob until the reading on the pressure gauge is **17 PSI**.

6.5.21.3 Push knob in to lock.

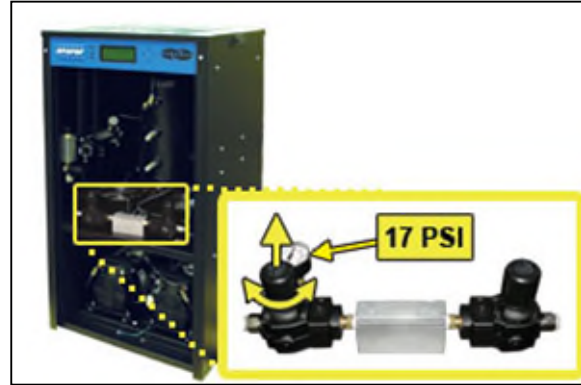

6.5.22 Set the Outlet Pressure:

6.5.22.1 When the Unit Screen (8.4.5.1) appears on the display, press the **HOLD Button** on the Front Panel to freeze that screen.

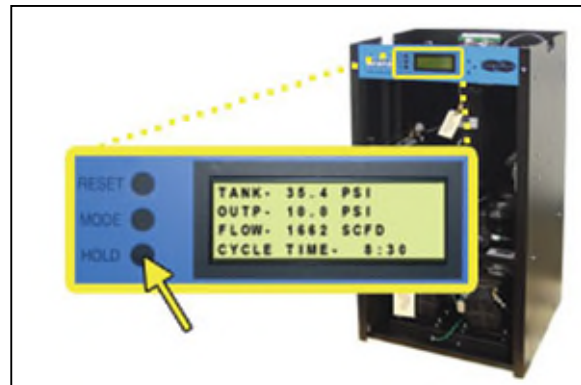

6.5.22.2 Pull the Outlet Pressure Regulator knob out.

6.5.22.3 Turn knob until Outlet Pressure (**OUTP**) reading is at the desired setting.



6.5.22.4 Push knob in to lock.

6.5.23 Check for air leaks:

NOTE: This is a general procedure that can be applied to any fitting or hose that has air pressure in it. **DO NOT SOAP TEST THE HUMITTER FITTING. DAMAGE TO THE HUMITTER MAY OCCUR.**

With Compressor(s) NOT running:

6.5.23.1 Listen for any 'hissing' sounds which may indicate a fitting or hose air leak.

With Compressor(s) running:

6.5.23.2 Use a 1-inch paint brush to dab soapy water on the air fitting or hose connection to be tested.

If air bubbles appear at the connection, this indicates that air is leaking from the connection.

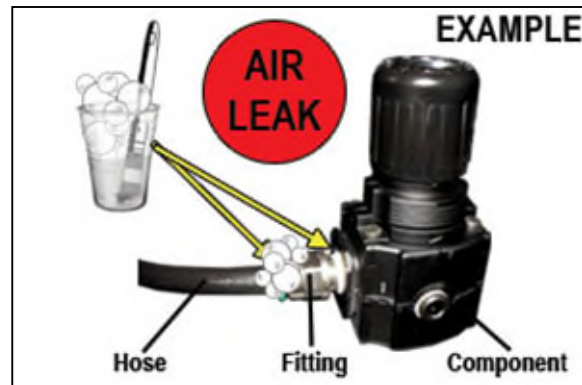

If any leaks are detected, take steps to seal them off (as necessary):

- *Tighten the fitting*
- *Re-connect the hose end*
- *Replace the fitting / hose / component*

6.5.24 Re-install the front panel.

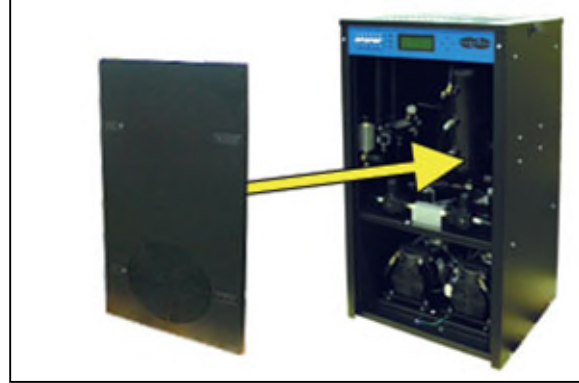

6.5.25 REGISTER YOUR DRYER. *See section 7. for details.*

6.6 Installation Checklist

- No shipping damage was detected.
- Dryer location meets the following requirements:
 - Well ventilated
 - Free from abrasive dust or chemicals
 - Ambient temperature is between 40° and 85° F (optimal)
 - Power outlet easily accessible
- Operating Power is between 210 – 230 VAC.
- Shipping block removed from compressor trays.
- System Pressures are set to 50 PSI.
- Static Pressure is set to 17 PSI.
- No air leaks are present in the system.
- No alarms are present on the Display Panel.

7. Registering Your Dryer

Please take a moment to register your RFS BD8400W Air-dryer. Registering is necessary to activate the Limited Warranty on your product. Once you register, you are eligible to receive free technical support, as well as updates concerning your RFS products.

Register Online at www.AltecAIR.com/registration

Or by Phone 1-800-521-5351 (option 2)

Have the following information available:

Model #: **BD8400W** Serial #: _____

Company Name: _____ Location Name: _____

Shipping Address: _____

City: _____ State: _____ Zip Code: _____

Contact Name: _____ Phone #: () - ext. _____

Email: _____

8. Operating Your Dryer

8.1 Safety & Warning Information



WARNING!

Extreme care should be exercised to avoid contact with live electrical circuits. Many procedures performed during installation, operation, testing, and maintenance of this air-dryer require the equipment to be running, creating a situation for potential electrical shock. It is highly recommended that you remove all jewelry before performing any procedures.



WARNING!

Internal surfaces may be hot. Use care when coming into contact with internal components as there is a potential for some of these components to become hot when in operation or standby.



WARNING!

High Noise. RFS air-dryers are meant to be installed in an unattended area.



CAUTION!

Observe precautions for handling **Electrostatic Sensitive Devices.**



IMPORTANT!

Performing procedures not described in this User's Guide or installing components not supplied by RFS is **NOT RECOMMENDED AND MAY VOID THE WARRANTY.**

8.2 Connecting Air Lines to the Dryer

8.2.1 Connect the air supply line to the dryer Outlet Pressure port (adjustable between 0-15 PSI)

⚠ CAUTION: Be careful when removing outlet plugs. System may be pressurized.

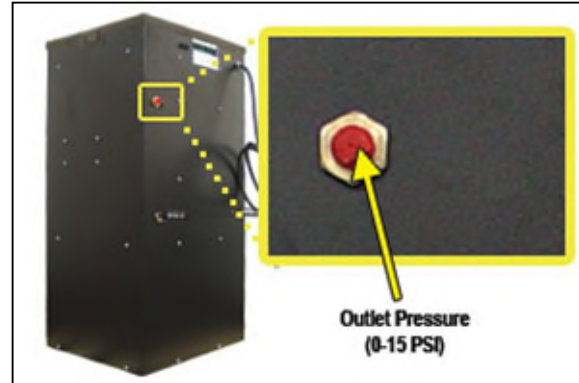

RFS recommends using Installation Kit P011752 to connect your air-dryer to the air supply line (See section 11.6 for detail).

8.3 Powering the Dryer ON & OFF

8.3.1 POWER Circuit Breaker - Controls the main power to the dryer. This must be in the **ON** position for either System 1 or System 2 to be powered ON.

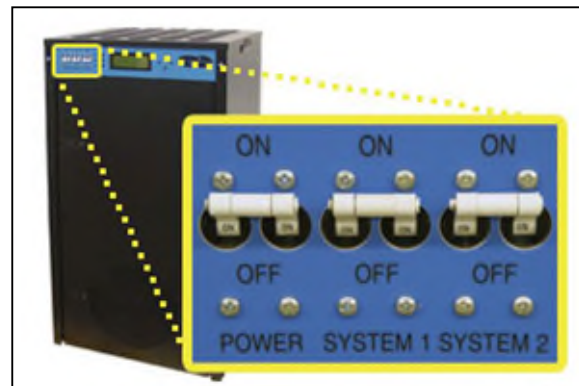

8.3.2 SYSTEM 1 Circuit Breaker - Turns System 1 ON/OFF.

8.3.3 SYSTEM 2 Circuit Breaker - Turns System 2 ON/OFF.

8.4 Using the Front Panel Display



CAUTION!

The Display Screen is covered by a clear protective layer that guards against Electrostatic Discharge (ESD). DO NOT REMOVE THIS LAYER.



8.4.1 RESET Button – Clears an alarm and allows the system to continue operating.

8.4.2 CENTER Button – Freezes the current information screen on the display. When pressed again, it will allow the information screens to begin cycling again.

8.4.3 Arrow Buttons – Used to access, navigate, and change values in the Set Point Adjust screens.

8.4.4 Contrast Adjust – On the back of the LCD there is a knob to adjust the contrast of the display. You may adjust this knob if your display is too light or too dark.

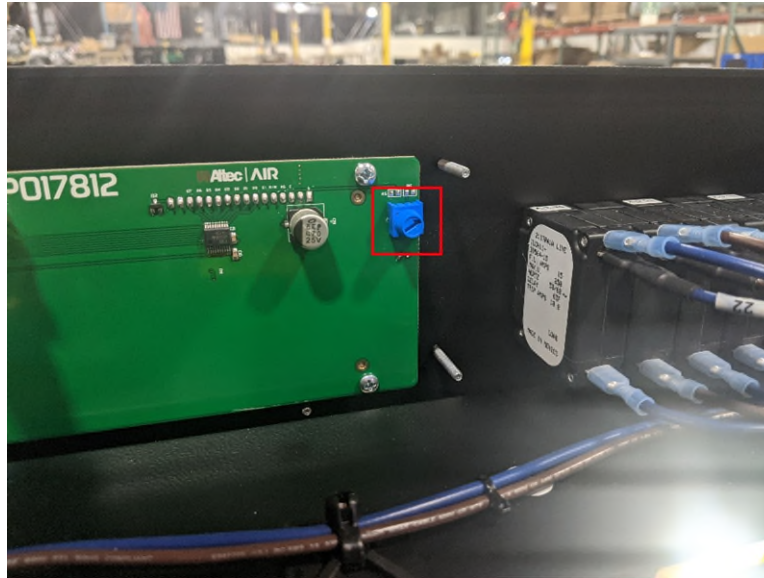

8.4.5 Display Screen - Shows the current dryer readings. Will cycle between the following information screens (unless the **HOLD** button has been pressed) You may also manually cycle through the screens by pressing the left or right arrow buttons:

8.4.5.1 Tank Screen



TANK – Air Tank pressure - fluctuates between 20 – 50 PSI.

OUTLET –Outlet Pressure regulated by the Outlet Pressure Regulator

FLOW – Air Flow Rate

8.4.5.2 Temperature Screen

```

TEMPERATURE:
CABINET-    69°F
COMP-       90°F
↔SEL  ↑SETUP  ●HOLD
  
```

COMP – Temperature of the lower compressor compartment.

CABINET – Temperature of the upper circuit board compartment.

8.4.5.3 System Screens (*System** = *System 1* or *System 2*)

<pre> SYSTEM 1 : ONLINE HUMIDITY- 1.5% DUTY CYCLE- 29% ↔SEL ↑SETUP ●HOLD </pre>	<pre> SYSTEM 2 : STANDBY HUMIDITY- 1.5% DUTY CYCLE- 29% ↔SEL ↑SETUP ●HOLD </pre>
---	--

SYSTEM* - Running Status of System*:

- **ONLINE**– System* is Online in the dryer cycle mode.
- **STANDBY** – System* is not Online in the dryer cycle mode.
- **SHUTDOWN** – System* has been shutdown as a result of either a Humidity, High Compressor Temperature, or High Cabinet Temperature alarm.

HUMIDITY – Humidity level of System*.

DUTY CYCLE – The percentage of time that the compressor was on during the last compressor pump-up cycle

8.4.5.4 System Runtime Screens

```

SYS 1 COMP RUN TIME:
LAST- 00:32 MIN
TOTAL- 154 HRS
↔SEL  ↑SETUP  ●HOLD
  
```

LAST – Last compressor runtime in minutes

TOTAL – Total compressor runtime in minutes

8.4.5.5 System Cycle Mode Screen



Displays the current System Cycle Mode setting:

- **24 HOUR CYCLE** – Cycles between System 1 & System 2 every 24 hours (when the **TIME** reaches 24:00). Puts one system Online and the other in Standby.
- **BOTH** – Runs both System 1 and System 2 simultaneously.
- **SYSTEM 1 ONLY** – Runs only System 1 and leaves System 2 in Standby.
- **SYSTEM 2 ONLY** - Runs only System 2 and leaves System 1 in Standby.
- **TIME** – The amount of elapsed in the 24-hour cycle

8.5 Identifying Dryer Alarms

8.5.1 High Outlet Pressure Alarm -

Occurs when the Outlet Pressure (**OUTP**) rises above the alarm set point for more than one (1) minute.

(Default setting is 12.0 PSI)

Press the Info (●) Button to see the detail of the alarm.

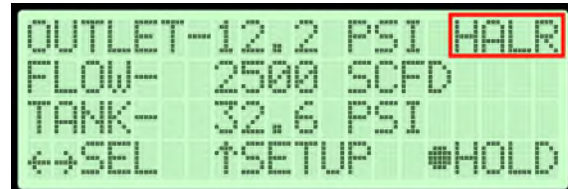

See section 13.5 for troubleshooting information.

8.5.2 Low Outlet Pressure Alarm –

Occurs when the Outlet Pressure (**OUTP**) drops below the alarm set point for more than one (1) minute. (Default setting is 6.5 PSI)
Press the Info (●) Button to see the detail of the alarm.

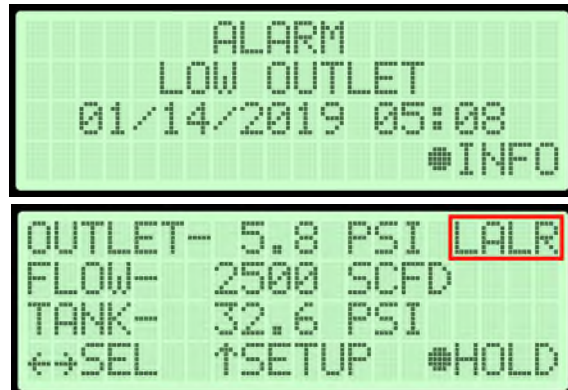

See section 13.7 for troubleshooting information.

8.5.3 High Flow Alarm –

Occurs when the Flow Rate (**FLOW**) rises above the alarm set point for more than one (1) minute. (Default setting is 4500 SCFD)
Press the Info (●) Button to see the detail of the alarm.

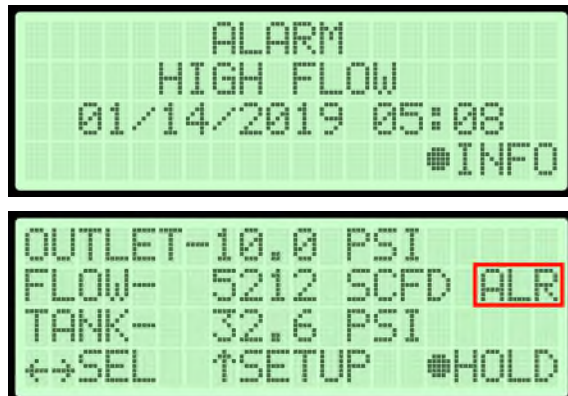

See section 13.9 for troubleshooting information.

8.5.4 High Compressor Temperature Alarm –

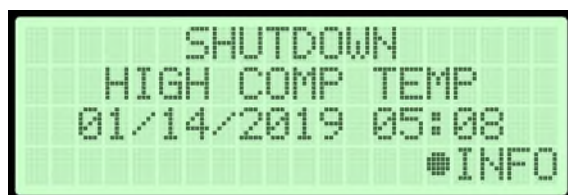

Occurs when the temperature in the lower compressor compartment rises above 120°F for more than one (1) minute.

If this alarm is present for one (1) minute or more, the air-dryer will go into

SHUTDOWN mode to

protect against damage due to overheating.

Press the Info (●) Button to see the detail of the alarm.

See section 13.16 for troubleshooting information.



8.5.5 High Cabinet Temperature Alarm -

Occurs when the temperature in the upper circuit board compartment rises above 120°F for more than one (1) minute.

If this alarm is present for one (1) minute or more, the air-dryer will go into

SHUTDOWN mode to protect against damage due to overheating.

Press the Info (●) Button to see the detail of the alarm.

See section 13.10 for troubleshooting information.



8.5.6 High Humidity Alarm –

Occurs when the Humidity level rises above the alarm set point for more than one (1) minute.

(Default setting is 10.0%)

If this alarm is present for one (1) minute or more, the air-dryer will go into

SHUTDOWN mode to prevent saturated air from being delivered to the supply line.

Press the Info (●) Button to see the detail of the alarm.

See section 13.11 for troubleshooting information.

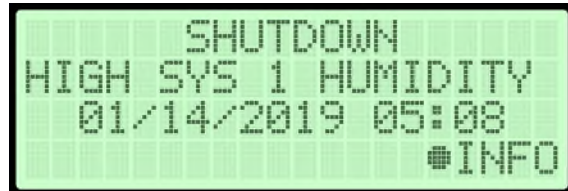

SHUTDOWN
HIGH SYS 1 HUMIDITY
01/14/2019 05:08
●INFO



SYSTEM 1 : SHUTDOWN
HUMIDITY- 10.2% ALR
DUTY CYCLE- 29%
↔SEL ↑SETUP ●HOLD

8.5.7 Compressor Excessive Run Time Alarm –

Occurs when the compressor takes longer to pressurize the air tank than the set point for the alarm. (Default setting is 3:00 minutes)

Press the Info (●) Button to see the detail of the alarm.



ALARM
COMP 1 LAST RUNTIME
01/14/2019 05:08
●INFO



SYS 1 COMP RUN TIME:
LAST- 09:59 MIN ALR
TOTAL- 154 HRS
↔SEL ↑SETUP ●HOLD

See section 13.17 for troubleshooting information.

8.5.8 High Duty Cycle Alarm –

Occurs when the compressor is active for a higher percentage of the time than the set point for the alarm. (Default settings is 70%)

Press the Info (●) Button to see the detail of the alarm.

```

ALARM
HIGH DUTY CYCLE
01/14/2019 05:08
#INFO
  
```

```

SYSTEM 1 : ONLINE
HUMIDITY- 1.5%
DUTY CYCLE- 90% ALR
←→SEL ↑SETUP #HOLD
  
```

See section 13.17 for troubleshooting information.

8.5.9 Compressor Total Hour Alarm –

Occurs when the compressor has reached an 8,000-hour maintenance interval. Perform the next required maintenance.

Press the Info (●) Button to see the detail of the alarm.

```

ALARM
COMP 1 TOTAL RUNTIME
01/14/2019 05:08
#INFO
  
```

```

SYS 1 COMP RUN TIME:
LAST- 09:59 MIN
TOTAL- 8002 HRS ALR
←→SEL ↑SETUP #HOLD
  
```

See section 10.3 for maintenance information.

8.6 Accessing the Setup Menu

The BD8400W has three (3) Setup sections:

- **System Setup** – Used to set system parameters including Cycle Mode, Cycle Time, Startup Delay, Alarm Delay, Date, Time, and Units. This menu also allows for firmware updates via USB.
- **Alarm Setup**– Used to set the alarm thresholds for specific readings. Once the threshold is reached (or exceeded) this results in an alarm. Each of these thresholds is factory programmed with a default value. Many of can be modified to levels based upon your specific application.
- **Network Setup** – Used to configure network settings including the IP Address, Subnet Mask, Gateway Address, Monitoring System Number and Keyword.



8.6.1 Press the Up (↑) Arrow Button to access the Setup Menu.

8.6.2 Press the Up (↑) & Down (↓) Arrow Buttons to Select the required menu option.

8.6.3 Press the Enter (●) Button to access the menu selected or press the Left (←) Arrow Button to Escape to the setup screen.

8.7 Using the System Setup Menu

In the Setup Menu:

- 8.7.1** Press the Up (↑) & Down (↓) Arrow Buttons to Select the “S” in System Setup.

```

SYSTEM SETUP
ALARM SETUP
NETWORK SETUP
←ESC  ↑↓SEL  ●ENTER
  
```

- 8.7.2** Press the Enter (●) Button to access System Setup.

8.7.3 Set Cycle Mode

- 8.7.3.1** Press the Enter (●) button to access the edit screen

```

SET SYS CYCLE MODE
      BOTH
←Esc  ↑↓Scroll  ●Enter
  
```

- 8.7.3.2** Press the Up (↑) and Down (↓) Arrow to select cycle mode

```

SET SYS CYCLE MODE
      24 HOUR
      ↑↓SEL  ●ENTER
  
```

- 8.7.3.3** Press the Enter (●) button to submit the selection

```

SET SYS CYCLE MODE
      24 HOUR
ARE YOU SURE  Y  N
      ↑↓Sel  ●Enter
  
```

- 8.7.3.4** Press the Left (←) & Right (→) Arrow Buttons to Select the correct confirmation choice (Yes or No).

8.7.4 Set Cycle Time

- 8.7.4.1** Press the Enter (●) Button to access the edit screen.

```

SET SYS CYCLE TIME
      18:36
←Esc  ↑↓Scroll  ●Enter
  
```

- 8.7.4.2** Press the Enter (●) Button to access the edit screen.

```

SET SYS CYCLE TIME
      18:36
Sel←→  ↑↓Chg  ●Enter
  
```

8.7.4.3 Press the Up (↑) and Down (↓) and Left (←) & Right (→) Arrow to select a digit

8.7.4.4 Press the Up (↑) and Down (↓) Arrow Buttons to Change the value of the selected digit.

8.7.4.5 Press the Enter (●) Button to confirm the selected choice.

```

SET SYS CYCLE TIME
  18:36
ARE YOU SURE Y N
Sel←→ ↑↓Chg ●Enter
  
```

8.7.4.6 Press the Left (←) & Right (→) Arrow Buttons to Select the correct confirmation choice (Yes or No).

8.7.4.7 Press the Enter (●) Button to confirm the selected choice. This will lock in the new setting.

8.7.5 Set Alarm Delay (default setting is ON) –

8.7.5.1 Press Up (↑) and Down (↓) to Select the correct choice (On or Off).

```

SET ALARM DELAY
  OFF
←Esc ↑↓Scroll ●Enter
  
```

8.7.5.2 Press the Enter (●) Button to submit the selection.

```

SET ALARM DELAY
  OFF
  ↑↓Sel ●Enter
  
```

8.7.5.3 Press the Left (←) & Right (→) Arrow Buttons to Select the correct confirmation choice (Yes or No).

8.7.5.4 Press the Enter (●) Button to confirm the selected choice. This will lock in the new setting.

```

SET ALARM DELAY
  OFF
ARE YOU SURE Y N
  ↑↓Sel ●Enter
  
```

8.7.6 Set Start Up Delay (default setting is 0 seconds) –

8.7.6.1 Press the Enter (●)

Button to access the edit screen.

```

SET STARTUP DELAY
  00 SECONDS
(DEFAULT= 0 SECONDS)
←Esc ↑↓Scroll #Enter
  
```

8.7.6.2 Press the Left (←) & Right (→) Arrow Buttons to Select the digit to change.

```

SET STARTUP DELAY
  00 SECONDS
(RANGE= 0-10)
  ↑↓Sel  #Enter
  
```

8.7.6.3 Press the Up (↑) & Down (↓) Arrow Buttons to Change the value of the selected digit.

```

SET STARTUP DELAY
  00 SECONDS
ARE YOU SURE Y N
  ↑↓Chg  #Enter
  
```

8.7.6.4 Press the Enter (●) Button to submit the new setting.

8.7.6.5 Press the Left (←) & Right (→) Arrow Buttons to Select the correct confirmation choice (Yes or No).

8.7.6.6 Press the Enter (●) Button to confirm the selected choice. This will lock in the new setting.

8.7.7 Reset Compressor Total Time –

8.7.7.1 Press the Enter (●) Button to access the reset screen.

8.7.7.2 Press the Left (←) & Right (→) Arrow Buttons to Select the correct

```

RESET SYS 1 COMP
TOTAL TIME- 3256 HRS
RESET SYS 1 COMP
TOTAL TIME TO 0 HRS
ARE YOU SURE Y N
  #Enter
  
```

confirmation choice (Yes or No).

8.7.7.3 Press the Enter (●) Button to confirm the selected choice. This will reset the Total Time to zero (0).

8.7.7.4 The process is similar for resetting System 2 runtime

8.7.8 Reset Factory Default Values –

8.7.8.1 Press the Enter (●) Button to access the reset screen.

RESET TO FACTORY
DEFAULT VALUES
+Esc ↑↓Scroll ●Enter

8.7.8.2 Press the Left (←) & Right (→) Arrow Buttons to Select the correct confirmation choice (Yes or No).

RESET TO FACTORY
DEFAULT VALUES
ARE YOU SURE Y N
SET CURRENT TIME
20:04
Sel←→ Chg↑↓ ●Enter

8.7.8.3 Press the Enter (●) Button to confirm the selected choice. This will reset all settings to Factory Default Values .

8.7.9 Set Date –

8.7.9.1 Press the Enter (●) Button to access the edit screen.

SET CURRENT DATE
01/14/2019
+Esc ↑↓Scroll ●Enter

8.7.9.2 Press the Left (←) & Right (→) Arrow Buttons to Select the digit to change.



8.7.9.3 Press the Up (↑) & Down (↓) Arrow Buttons to Change the value of the selected digit.

8.7.9.4 Press the Enter (●) Button to submit the new setting.

8.7.9.5 Press the Left (←) & Right (→) Arrow Buttons to Select the correct confirmation choice (Yes or No).



8.7.9.6 Press the Enter (●) Button to confirm the selected choice. This will lock in the new setting.

8.7.10 Set Time –

8.7.10.1 Press the Enter (●) Button to access the edit screen.

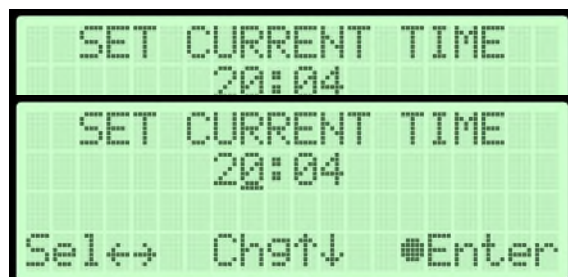

8.7.10.2 Press the Left (←) & Right (→) Arrow Buttons

to Select the digit to change.

8.7.10.3 Press the Up (↑) & Down (↓) Arrow Buttons to Change the value of the selected digit.

8.7.10.4 Press the Enter (●) Button to submit the new setting.

8.7.10.5 Press the Left (←) & Right (→) Arrow Buttons to Select the correct confirmation choice (Yes or No).

SET CURRENT TIME
20:04
ARE YOU SURE Y N
Sel←→ Chg↑↓ #Enter

8.7.10.6 Press the Enter (●) Button to confirm the selected choice. This will lock in the new setting.

8.7.11 Firmware Update –

8.7.11.1 Insert a USB drive containing an appropriate “.pgz” firmware file from RFS into the USB A port on the control board.

FIRMWARE UPDATE
VERSION: 0.1.2
LIB : 0.1.0
←Esc ↑↓Sel #Update

8.7.11.2 Press the Enter (●) Button to access the Firmware Update Screen.

ENTER KEYWORD
000000
UPDATING FIRMWARE
DEVICE WILL RESET

8.7.11.3 Enter the device keyword and press the Enter (●) Button to access the firmware update screen.

8.7.11.4 Select the correct file version using the Up (↑) and Down (↓) Buttons

8.7.11.5 Press the Enter (●) button to select the file

8.7.11.6 Press the Left (←) & Right (→) Arrow Buttons to Select the correct confirmation choice (Yes or No) and begin the update.

8.7.12 System Units–

8.7.12.1 Press the Enter (●) Button to access the edit screen.

8.7.12.2 Press the Up (↑) and Down (↓) Arrow Buttons to Change the value.

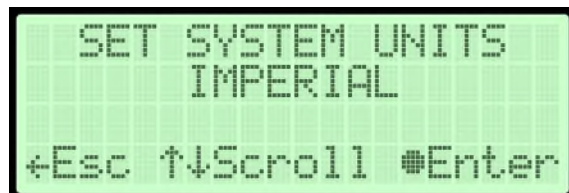

```

SET SYSTEM UNITS
IMPERIAL
+Esc ↑↓Scroll ●Enter

```

8.7.12.3 Press the Enter (●) Button to submit the new setting.

8.7.12.4 Press the Left (←) & Right (→) Arrow Buttons to Select the correct confirmation choice (Yes or No).

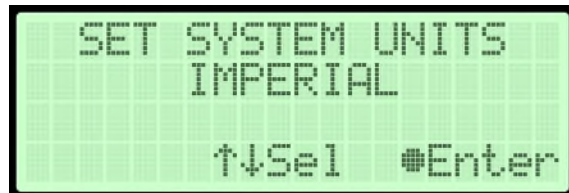

```

SET SYSTEM UNITS
IMPERIAL
↑↓Sel ●Enter

```

8.7.12.5 Press the Enter (●) Button to confirm the

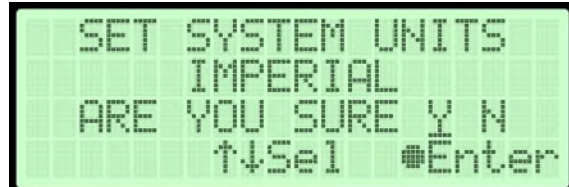

```

SET SYSTEM UNITS
IMPERIAL
ARE YOU SURE Y N
↑↓Sel ●Enter

```

selected choice. This will lock in the new setting.

8.8 Using the Alarm Setup Menu

In the Setup Menu:

8.8.1 Press the Up (↑) & Down (↓) Arrow Buttons to Select the "A" in Alarm Setup.



```

SYSTEM SETUP
ALARM SETUP
NETWORK SETUP
+ESC ↑↓SEL ●ENTER

```

8.8.2 Press the Enter (●) Button to access Alarm Setup.

8.8.3 Set High Humidity Threshold (default setting is 10%) –

- 8.8.3.1** Press the Enter (●) Button to access the edit screen.

```

SET HIGH HUMIDITY
THRESHOLD- 5.0%
(DEFAULT= 10.0%)
←Esc ↑↓Scroll ●Enter
  
```

- 8.8.3.2** Press the Left (←) & Right (→) Arrow Buttons to select the digit to change.

```

SET HIGH HUMIDITY
THRESHOLD- 10.0%
(RANGE= 3.0-15.0)
←→SEL ↑↓CHG ●ENTER
  
```

- 8.8.3.3** Press the Up (↑) & Down (↓) Arrow Buttons to Change the value of the selected digit.

- 8.8.3.4** Press the Enter (●) Button when to submit the new setting.

- 8.8.3.5** Press the Left (←) & Right (→) Arrow Buttons to Select the correct confirmation choice (Yes or No).

```

SET HIGH DUTY CYCLE
THRESHOLD- 70%
ARE YOU SURE Y N
SEL←→ ↑↓Chg ●ENTER
  
```

- 8.8.3.6** Press the Enter (●) Button to confirm the selected choice. This will lock in the new setting.

8.8.4 Set High Outlet Threshold (default setting is 20.00 PSI) –

- 8.8.4.1** Press the Enter (●) Button to access the edit screen.

```

SET HIGH OUTLET
THRESHOLD- 10.5 PSI
(RANGE= 0.4-20.4)
←→Sel ↑↓Chg ●Enter
  
```

8.8.4.2 Press the Left (←) & Right (→) Arrow Buttons to Select the digit to change.

8.8.4.3 Press the Up (↑) & Down (↓) Arrow Buttons to Change the value of the selected digit.

SET HIGH OUTLET
THRESHOLD- 10.5 PSI
(DEFAULT= 20.0 PSI)
+ESC ↑↓SCROLL #ENTER

8.8.4.4 Press the Enter (●) Button when to submit the new setting.

8.8.4.5 Press the Left (←) & Right (→) Arrow Buttons to Select the correct confirmation choice (Yes or No).

SET HIGH OUTLET
THRESHOLD- 10.5 PSI
ARE YOU SURE Y N
+→Sel ↑↓Chg #Enter

8.8.4.6 Press the Enter (●) Button to confirm the selected choice. This will lock in the new setting.

8.8.5 Set Low Pressure Threshold (default setting is 0.30 PSI) –

8.8.5.1 Press the Enter (●) Button to access the edit screen.

8.8.5.2 Press the Left (←) & Right (→) Arrow Buttons to Select the digit to change.

SET LOW OUTLET
THRESHOLD- 0.2 PSI
(DEFAULT= 0.3 PSI)
+Esc ↑↓Scroll #Enter

8.8.5.3 Press the Up (↑) & Down (↓) Arrow Buttons to Change the value of the selected digit.

SET LOW OUTLET
THRESHOLD- 0.3 PSI
(RANGE= 0.3-19.9)
+→SEL ↑↓CHG #ENTER

8.8.5.4 Press the Enter (●) Button when to submit the new setting.

8.8.5.5 Press the Left (←) & Right (→) Arrow Buttons to Select the correct confirmation choice (Yes or No).

SET LOW OUTLET
THRESHOLD- 0.3 PSI
ARE YOU SURE Y N
SEL<-> ↑↓Chg #ENTER

8.8.5.6 Press the Enter (●) Button to confirm the selected choice. This will lock in the new setting

8.8.6 Set High Flow Threshold (default setting is 4500 SCFD)

8.8.6.1 Press the Enter (●) Button to access the edit screen.

8.8.6.2 Press the Left (←) & Right (→) Arrow Buttons to Select the digit to change.

SET HIGH FLOW
THRESHOLD- 6400 SCFD
(DEFAULT= 4500 SCFD)
←Esc ↑↓Scroll #Enter

8.8.6.3 Press the Up (↑) & Down (↓) Arrow Buttons to Change the value of the selected digit.

SET HIGH FLOW
THRESHOLD- 4500 SCFD
(RANGE= 0-6500)
←>SEL ↑↓CHG #ENTER

8.8.6.4 Press the Enter (●) Button when to submit the new setting.

8.8.6.5 Press the Left (←) & Right (→) Arrow Buttons to Select the correct confirmation choice (Yes or No).

SET HIGH FLOW
THRESHOLD- 4500 SCFD
ARE YOU SURE Y N
SEL←→ ↑↓Chg #ENTER

8.8.6.6 Press the Enter (●) Button to confirm the selected choice. This will lock in the new setting.

8.8.7 Set Compressor Last Run Threshold (default setting is 3:00 min)

8.8.7.1 Press the Enter (●) Button to access the edit screen.

8.8.7.2 Press the Left (←) & Right (→) Arrow Buttons to Select the digit to change.

SET COMP LAST RUN
THRESHOLD- 02:30 MIN
(DEFAULT= 03:00 MIN)
←Esc ↑↓Scroll #Enter

8.8.7.3 Press the Up (↑) & Down (↓) Arrow Buttons to Change the value of the selected digit.

SET COMP LAST RUN
THRESHOLD- 03:00 MIN
(RANGE= 01:00-59:59)
←→SEL ↑↓CHG #ENTER

8.8.7.4 Press the Enter (●) Button when to submit the new setting.

8.8.7.5 Press the Left (←) & Right (→) Arrow Buttons to Select the correct confirmation choice (Yes or No).

```

SET COMP LAST RUN
THRESHOLD- 03:00 MIN
ARE YOU SURE Y N
SEL←→ ↑↓Chg #ENTER
  
```

8.8.7.6 Press the Enter (●) Button to confirm the selected choice. This will lock in the new setting.

8.8.8 Set Duty Cycle Threshold (default setting is 70%)

8.8.8.1 Press the Enter (●) Button to access the edit screen.

```

SET HIGH DUTY CYCLE
THRESHOLD- 65 %
(DEFAULT= 70 %)
←Esc ↑↓Scroll #Enter
  
```

8.8.8.2 Press the Left (←) & Right (→) Arrow Buttons to Select the digit to change.

```

SET HIGH DUTY CYCLE
THRESHOLD- 70%
(RANGE= 1-99 %)
←→SEL ↑↓CHG #ENTER
  
```

8.8.8.3 Press the Up (↑) & Down (↓) Arrow Buttons to Change the value of the selected digit.

8.8.8.4 Press the Enter (●) Button when to submit the new setting.

8.8.8.5 Press the Left (←) & Right (→) Arrow Buttons to Select the correct confirmation choice (Yes or No).

SET HIGH DUTY CYCLE
THRESHOLD- 70%
ARE YOU SURE Y N
SEL←→ ↑↓Chg ●ENTER

8.8.8.6 Press the Enter (●) Button to confirm the selected choice. This will lock in the new setting.

8.9 Using the Network Setup Menu

In the Setup Menu:

8.9.1 Press the Up (↑) & Down (↓) Arrow Buttons to Select the “N” in Network Setup.

8.9.1.1 Press the Enter (●) Button to access Network Setup.

SYSTEM SETUP
ALARM SETUP
NETWORK SETUP
←ESC ↑↓SEL ●ENTER

8.9.2 Enter Keyword (default Keyword is 123456) –

8.9.2.1 Press the Left (←) & Right (→) Arrow Buttons to Select the digit to change.

ENTER KEYWORD
000000
←→Sel ↑↓Chg ●Enter

8.9.2.2 Press the Up (↑) & Down (↓) Arrow Buttons to Change the value of the selected digit.

8.9.2.3 Press the Enter (●) Button to submit the Keyword.

8.9.3 Set IP Address (default is 192.168.1.100) –

8.9.3.1 Press the Enter (●) Button to access the edit screen.

8.9.3.2 Press the Left (←) & Right (→) Arrow Buttons to Select the digit to change.

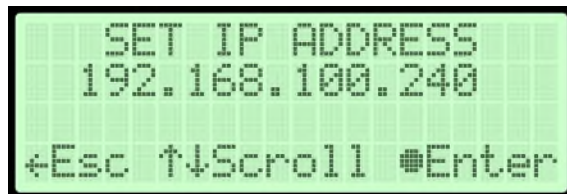

```

SET IP ADDRESS
192.168.100.240
←Esc ↑↓Scroll ●Enter
  
```

8.9.3.3 Press the Up (↑) & Down (↓) Arrow Buttons to Change the value of the selected digit.



```

SET IP ADDRESS
292.168.100.240
Sel←→ Ch9↑↓ ●Enter
  
```

8.9.3.4 Press the Enter (●) Button when to submit the new setting.

8.9.3.5 Press the Left (←) & Right (→) Arrow Buttons to Select the correct confirmation choice (Yes or No).

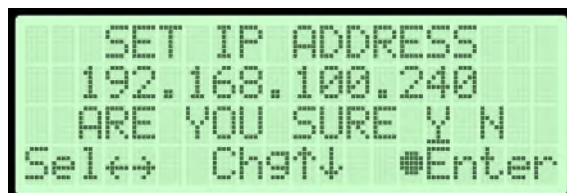

```

SET IP ADDRESS
192.168.100.240
ARE YOU SURE Y N
Sel←→ Ch9↑↓ ●Enter
  
```

8.9.3.6 Press the Enter (●) Button to confirm the selected choice. This will lock in the new setting.

8.9.4 Set Subnet Mask (default is 255.255.255.000) –

8.9.4.1 Press the Enter (●) Button to access the edit screen.

8.9.4.2 Press the Left (←) & Right (→) Arrow Buttons to Select the digit to change.

```

SET SUBNET MASK
255.255.255. 0
←Esc ↑↓Scroll ●Enter
  
```

8.9.4.3 Press the Up (↑) & Down (↓) Arrow Buttons to Change the value of the selected digit.

```

SET SUBNET MASK
255.255.255. 0
←→Sel ↑↓Chg ●Enter
  
```

8.9.4.4 Press the Enter (●) Button when to submit the new setting.

8.9.4.5 Press the Left (←) & Right (→) Arrow Buttons to Select the correct confirmation choice (Yes or No).

```

SET SUBNET MASK
255.255.255. 0
ARE YOU SURE Y N
Sel←→ Chg↑↓ ●Enter
  
```

8.9.4.6 Press the Enter (●) Button to confirm the selected choice. This will lock in the new setting.

8.9.5 Set Gateway Address (default is 000.000.000.000) –

8.9.5.1 Press the Enter (●) Button to access the edit screen.

8.9.5.2 Press the Left (←) & Right (→) Arrow Buttons to Select the digit to change.

```

SET GATEWAY ADDRESS
192.100.240 11
←Esc ↑↓Scroll ●Enter
  
```

```

SET GATEWAY ADDRESS
192.168.100. 11
Sel←→ Chg↑↓ ●Enter
  
```

8.9.5.3 Press the Up (↑) & Down (↓) Arrow Buttons to Change the value of the selected digit.

8.9.5.4 Press the Enter (●) Button when to submit the new setting.

8.9.5.5 Press the Left (←) & Right (→) Arrow Buttons to Select the correct confirmation choice (Yes or No).



```

SET GATEWAY ADDRESS
192.100.240 11
ARE YOU SURE Y N
←→Sel  ↑↓Chg  ●Enter
  
```

8.9.5.6 Press the Enter (●) Button to confirm the selected choice. This will lock in the new setting.

8.9.6 Set SNMP Trap Server (default is 000.000.000.000) –

8.9.6.1 Press the Enter (●) Button to access the edit screen.

8.9.6.2 Press the Left (←) & Right (→) Arrow Buttons to Select the digit to change.

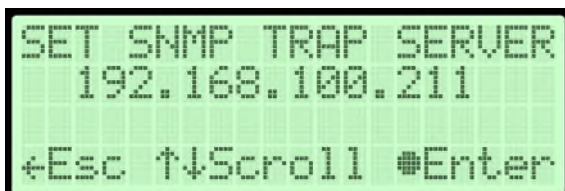

```

SET SNMP TRAP SERVER
192.168.100.211
←Esc  ↑↓Scroll  ●Enter
  
```

8.9.6.3 Press the Up (↑) & Down (↓) Arrow Buttons to Change the value of the selected digit.



```

SET SNMP TRAP SERVER
192.168.100.211
←→Sel  ↑↓Chg  ●Enter
  
```

8.9.6.4 Press the Enter (●) Button when to submit the new setting.

8.9.6.5 Press the Left (←) & Right (→) Arrow Buttons to Select the correct confirmation choice (Yes or No).

```

SET SNMP TRAP SERVER
 192.168.100.211
 ARE YOU SURE Y N
 ←→Sel ↑↓Chg #Enter
  
```

8.9.6.6 Press the Enter (●) Button to confirm the selected choice. This will lock in the new setting.

8.9.7 Change Keyword (default is 123456) –

8.9.7.1 Press the Enter (●) Button to access the edit screen.

8.9.7.2 Press the Left (←) & Right (→) Arrow Buttons to Select the digit to change.

```

CHANGE KEYWORD
 000000
 ←Esc ↑↓Scroll #Enter
  
```

8.9.7.3 Press the Up (↑) & Down (↓) Arrow Buttons to Change the value of the selected digit.

```

CHANGE KEYWORD
 000000
 ←→Sel ↑↓Chg #Enter
  
```

8.9.7.4 Press the Enter (●) Button when to submit the new setting.

8.9.7.5 Press the Left (←) & Right (→) Arrow Buttons to Select the correct confirmation choice (Yes or No).

```

CHANGE KEYWORD
 000000
 ARE YOU SURE Y N
 ←→Sel ↑↓Chg #Enter
  
```

8.9.7.6 Press the Enter (●) Button to confirm the selected choice. This will lock in the new settings

8.9.8 Set Monitoring System Address (default is 0) –

8.9.8.1 Press the Enter (●) Button to access the edit screen.

8.9.8.2 Press the Up (↑) & Down (↓) Arrow Buttons to Change the value

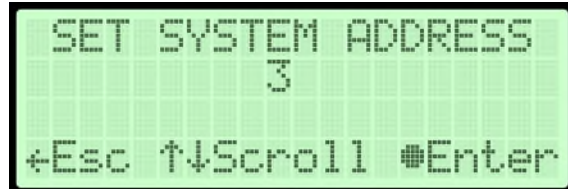

```

SET SYSTEM ADDRESS
  3
←Esc ↑↓Scroll ●Enter
  
```

8.9.8.3 Press the Enter (●) Button when to submit the new setting.

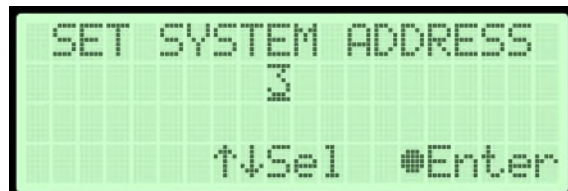

```

SET SYSTEM ADDRESS
  3
      ↑↓Sel  ●Enter
  
```

8.9.8.4 Press the Left (←) & Right (→) Arrow Buttons to Select the correct confirmation choice (Yes or No).

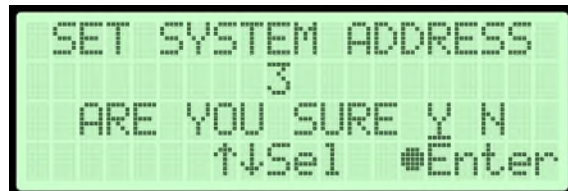

```

SET SYSTEM ADDRESS
  3
ARE YOU SURE Y N
      ↑↓Sel  ●Enter
  
```

8.9.8.5 Press the Enter (●) Button to confirm the selected choice. This will lock in the new setting.

8.9.9 View MAC address

8.9.9.1 The device MAC address can be viewed from the network setup menu



```

MAC ADDRESS
00:0A:95:9D:68:16
←ESC  ↑↓SEL
  
```

8.10 Opening Panels

8.10.1 Removing Top Cover –

Depress the latches and pull the Top Cover off. The top cover is equipped with locking latches if a higher level of security is required.

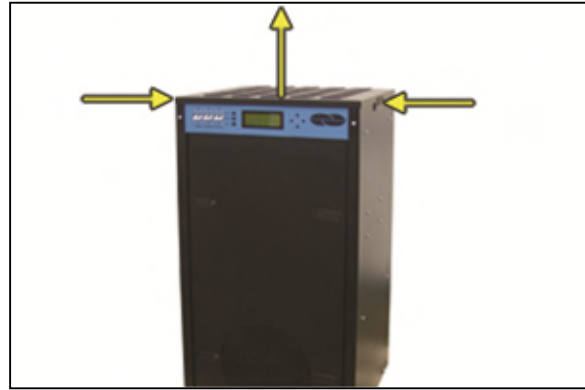

8.10.2 Removing Front Panel –

Depress the latches and pull the Front Panel out. The front panel is equipped with locking latches if a higher level of security is required.



8.11 Depressurizing the Dryer

8.11.1 Remove Front Panel (see section 8.10.2)

8.11.2 Pull the ring handle on the Safety Relief Valve until all air pressure is released.

8.11.3 To prevent pressure from building back up, power the dryer **OFF** (See section 8.3 for detail).

8.11.4 Reinstall Front Panel.

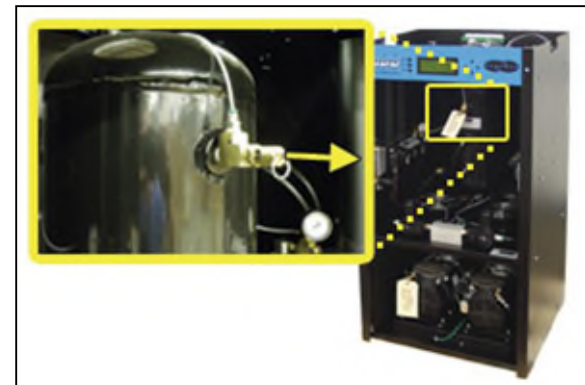

8.12 Setting the System Pressure

System 1 & System 2 are adjusted and set independently.

With Compressor running:

8.12.1 Remove Front Panel (see section 8.10.2)

8.12.2 Pull the Capacity Control Valve knob out.

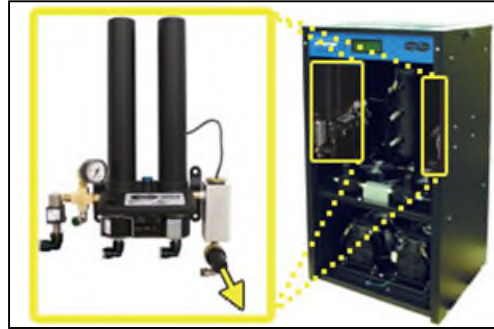

8.12.3 Turn the knob until the reading on the Pressure Gauge is **50 PSI**.

8.12.4 Push the knob in to lock.

8.12.5 Reinstall Front Panel.



8.13 Setting the Static Pressure

8.13.1 Remove Front Panel (see section 8.10.2)

8.13.2 Pull Static Pressure Regulator knob out.

8.13.3 Turn knob until the reading on the pressure gauge is **17 PSI**.

8.13.4 Push knob in to lock.

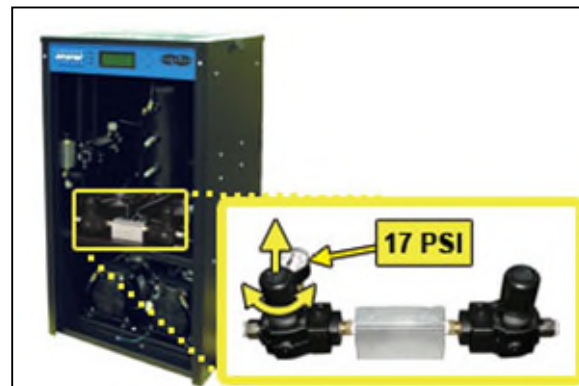

8.13.5 Reinstall Front Panel.

8.14 Setting the Outlet Pressure

8.14.1 Remove Front Panel (see section 8.10.2)

8.14.2 When the Unit Screen (8.4.5.1) appears on the display, press the **HOLD** Button on the Front Panel to freeze that screen.

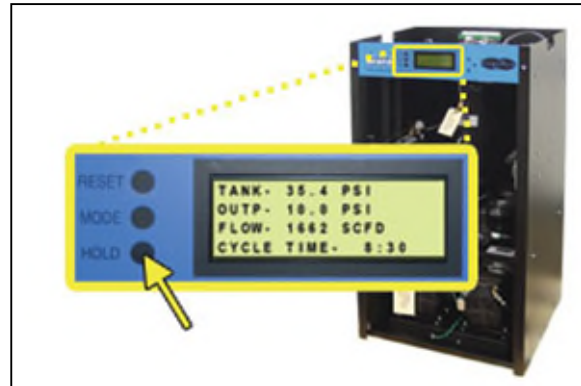

8.14.3 Pull the Outlet Pressure Regulator knob out.

8.14.4 Turn knob until Outlet Pressure (**OUTP**) reading is at the desired setting.

8.14.5 Push knob in to lock.

8.14.6 Reinstall Front Panel.



8.15 Engaging the Boost Transformer

8.15.1 See section 6.5.13

8.16 Connecting via Web Browser

Warning

The intra-building port (Network/LAN Port) of the equipment is suitable for connection to intra-building or unexposed wiring or cabling only. The intra-building port(s) of the equipment **MUST NOT** be metallically connected to interfaces that connect to the OSP.

The intra-building port (Network/LAN Port) of the BD8400W must use shielded intra-building cabling/wiring that is grounded at both ends.

If the Air-dryer IS connected to an IP network:

- The Air-dryer must be configured with a valid IP Address, Subnet Mask, and Gateway Address for the network.
- An IP cable must be connecting the air-dryer to the network.
- Use a computer that is on the same network as the air-dryer.
- Use Internet Explorer (6.0 or newer), Mozilla Firefox or Google Chrome.

If the Air-dryer IS NOT connected to an IP network and has not been configured with IP information:

- Use the default IP Address (*192.168.1.102*) of the air-dryer to connect.
- Use an IP Cable (may require Cross-over cable) plugged directly into a Laptop/PC and the other end plugged into the Network Port of the air-dryer.

- Configure the network card on the Laptop/PC to use the IP Address *192.168.1.102*. This will make the Laptop/PC compatible with the air-dryer.
- Use Internet Explorer (6.0 or newer) Mozilla Firefox or Goggle Chrome Web Browser.

8.16.1 Type the IP Address of the BD8400W Series Air-dryer in the Address text box of the Web Browser.

The Web Browser connection offers five (5) screens to the user:

- **Status Screen** - Displays the readings and alarms monitored in the BD8400W Series Air-dryer. Provides remote ALARM RESET.
- **Setup Screen** - All configurations for System, Alarms, Network, and Keyword can be made in this screen.
- **Event Screen** - Displays all events such as alarms, changes made, and alarm resets registered by the BD8400W Series Air-dryer. This screen is informational only.
- **Alarm Screen** - Displays all the Alarms registered by the BD8400W Series Air-dryer. This screen is informational only.
- **Firmware Screen** – Allows the user to upload any software updates or upgrades to the Air-dryer.



8.16.2 Click on the Menu Bar selection to access a specific screen.

8.17 Using the Status Screen

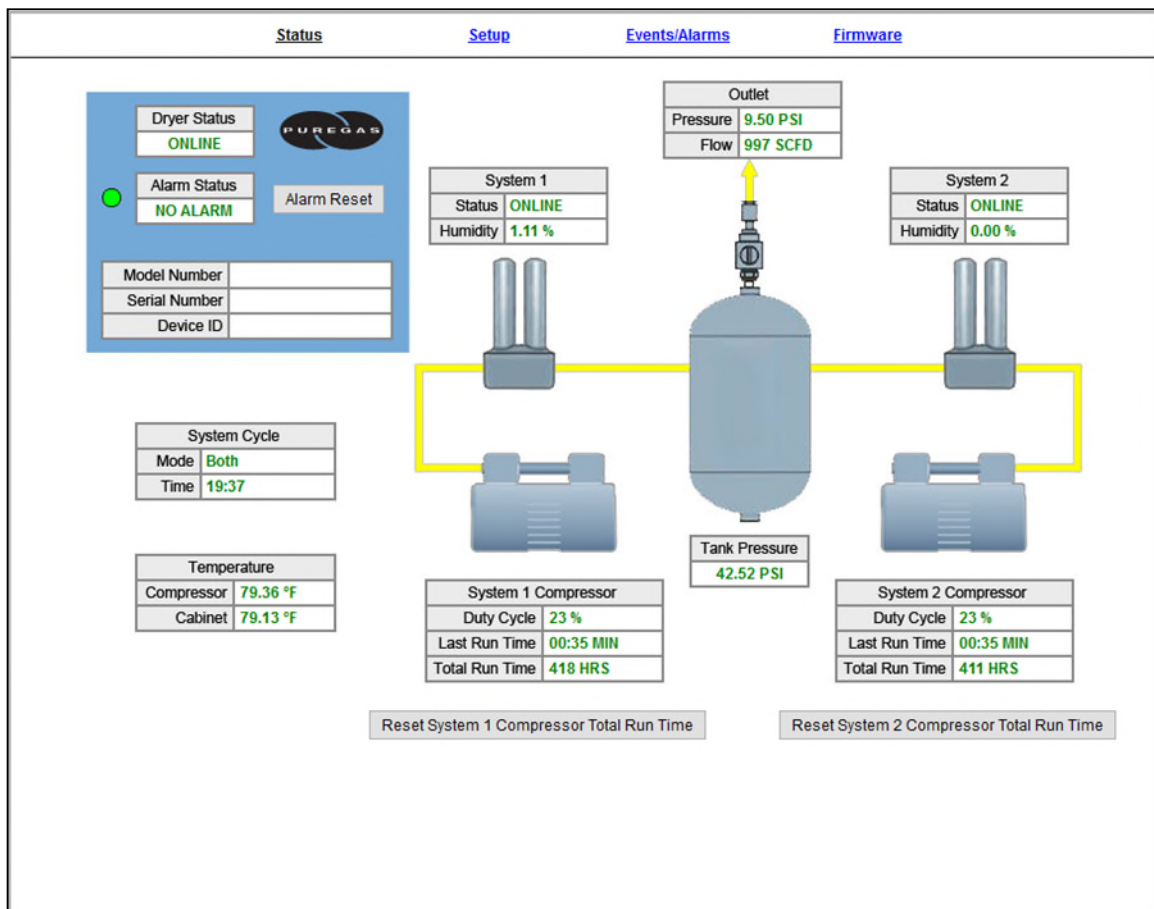

The Status Screen Displays the readings and alarms monitored in the BD8400W Series Air-dryer. Provides remote ALARM RESET.

- Readings are displayed in **GREEN** unless an alarm is present.
- Alarms are displayed in **RED** next to the parameter in alarm.
- Alarm Status will display **ALARM** if any alarms are present.

8.17.1 Resetting an Alarm

8.17.1.1 Click on the **ALARM RESET** Button to remotely reset Air-dryer alarms displayed on Status Screen.

8.17.2 Resetting a Compressor Total Run Time

8.17.2.1 Click on the **RESET COMPRESSOR TOTAL RUN TIME** Button to remotely reset Compressor Total Run Time displayed on Status Screen.

8.18 Using the Setup Screen

All configurations for the System, Alarms, Network, and Keyword can be made in this screen.

- Values in **BLUE** represent the current setting.
- The **ENTER** Button is used to change values.
- Clicking the “*****” field next to Keyword allows the user to change the keyword
- Keyword validation is required for any changes on the page

- In order to unlock the page, click on the Lock Icon at the top right hand corner of the page and enter the keyword

Status	Setup	Events/Alarms	Firmware																																			
<p>SYSTEM SETUP </p> <table border="1"> <thead> <tr> <th>Description</th> <th>Setting</th> </tr> </thead> <tbody> <tr> <td>System Cycle Mode</td> <td>BOTH</td> </tr> <tr> <td>System Cycle Time</td> <td>19:37</td> </tr> <tr> <td>Alarm Delay</td> <td><input type="radio"/> ON <input checked="" type="radio"/> OFF</td> </tr> <tr> <td>Startup Delay</td> <td>NONE</td> </tr> <tr> <td>Units</td> <td>Imperial</td> </tr> <tr> <td>Current Date</td> <td>01/06/2020</td> </tr> <tr> <td>Current Time</td> <td>08:50</td> </tr> <tr> <td>Device ID</td> <td></td> </tr> <tr> <td>Keyword</td> <td>*****</td> </tr> </tbody> </table>				Description	Setting	System Cycle Mode	BOTH	System Cycle Time	19:37	Alarm Delay	<input type="radio"/> ON <input checked="" type="radio"/> OFF	Startup Delay	NONE	Units	Imperial	Current Date	01/06/2020	Current Time	08:50	Device ID		Keyword	*****															
Description	Setting																																					
System Cycle Mode	BOTH																																					
System Cycle Time	19:37																																					
Alarm Delay	<input type="radio"/> ON <input checked="" type="radio"/> OFF																																					
Startup Delay	NONE																																					
Units	Imperial																																					
Current Date	01/06/2020																																					
Current Time	08:50																																					
Device ID																																						
Keyword	*****																																					
<p>ALARM SETUP Reset All Alarm Settings To Factory Default Values</p> <table border="1"> <thead> <tr> <th>Description</th> <th>Default</th> <th>Range</th> <th>Current Setting</th> <th>Unit</th> </tr> </thead> <tbody> <tr> <td>High Outlet Pressure</td> <td>20</td> <td>0.4 - 20</td> <td>20.0</td> <td>PSI</td> </tr> <tr> <td>Low Outlet Pressure</td> <td>0.3</td> <td>0.3 - 19.9</td> <td>0.3</td> <td>PSI</td> </tr> <tr> <td>High Flow</td> <td>4500</td> <td>0 - 6500</td> <td>4500.0</td> <td>SCFD</td> </tr> <tr> <td>High Humidity</td> <td>10.0</td> <td>3.0 - 15.0</td> <td>10.0</td> <td>%</td> </tr> <tr> <td>High Duty Cycle</td> <td>70</td> <td>0 - 99</td> <td>70</td> <td>%</td> </tr> <tr> <td>High Compressor Last Run Time</td> <td>3:00</td> <td>1:00 - 59:59</td> <td>03:00</td> <td>MIN:SEC</td> </tr> </tbody> </table>				Description	Default	Range	Current Setting	Unit	High Outlet Pressure	20	0.4 - 20	20.0	PSI	Low Outlet Pressure	0.3	0.3 - 19.9	0.3	PSI	High Flow	4500	0 - 6500	4500.0	SCFD	High Humidity	10.0	3.0 - 15.0	10.0	%	High Duty Cycle	70	0 - 99	70	%	High Compressor Last Run Time	3:00	1:00 - 59:59	03:00	MIN:SEC
Description	Default	Range	Current Setting	Unit																																		
High Outlet Pressure	20	0.4 - 20	20.0	PSI																																		
Low Outlet Pressure	0.3	0.3 - 19.9	0.3	PSI																																		
High Flow	4500	0 - 6500	4500.0	SCFD																																		
High Humidity	10.0	3.0 - 15.0	10.0	%																																		
High Duty Cycle	70	0 - 99	70	%																																		
High Compressor Last Run Time	3:00	1:00 - 59:59	03:00	MIN:SEC																																		
<p>NETWORK SETUP</p> <table border="1"> <thead> <tr> <th>Description</th> <th>Setting</th> </tr> </thead> <tbody> <tr> <td>IP Address</td> <td>10.50.137.15</td> </tr> <tr> <td>Subnet Mask</td> <td>255.255.255.192</td> </tr> <tr> <td>Gateway Address</td> <td>10.50.137.1</td> </tr> <tr> <td>SNMP Trap Server Address</td> <td>0. 0. 0. 0</td> </tr> </tbody> </table>				Description	Setting	IP Address	10.50.137.15	Subnet Mask	255.255.255.192	Gateway Address	10.50.137.1	SNMP Trap Server Address	0. 0. 0. 0																									
Description	Setting																																					
IP Address	10.50.137.15																																					
Subnet Mask	255.255.255.192																																					
Gateway Address	10.50.137.1																																					
SNMP Trap Server Address	0. 0. 0. 0																																					

8.18.1 Changing a Threshold or Setup value:

- 8.18.1.1 Click on the value to change.
- 8.18.1.2 Type in the new value.
- 8.18.1.3 Click the **ENTER** Button when done.
- 8.18.1.4 Enter Keyword

8.18.2 Changing the Keyword

- 8.18.2.1 Click on “*****” field next to keyword to change the keyword.
- 8.18.2.2 Type the Old Keyword.
- 8.18.2.3 Type the New Keyword.
- 8.18.2.4 Click on **SUBMIT** Button to confirm. This will lock in the new setting value.

8.19 Using the Event/Alarm Screen

		Status	Setup	Events/Alarms	Firmware
Event Type	Description				Timestamp 
Info	Unit Power On (Firmware: 0.1.2 Library: 0.1.0)				1/3/2020, 11:15:22 AM
Info	Unit Power On (Firmware: 0.1.2 Library: 0.1.0)				12/20/2019, 10:20:48 AM
Info	Unit Power On (Firmware: 0.1.2 Library: 0.1.0)				12/19/2019, 3:21:01 PM
Info	Unit Power On (Firmware: 0.1.2 Library: 0.1.0)				12/19/2019, 10:08:54 AM
Info	Unit Power On (Firmware: 0.1.2 Library: 0.1.0)				12/18/2019, 4:12:59 PM
Info	Unit Power On (Firmware: 0.1.2 Library: 0.1.0)				12/17/2019, 3:28:51 PM
Info	Alarms Reset				12/16/2019, 3:44:20 PM
Alarm	High Compressor 1 Last Runtime				12/16/2019, 1:31:17 PM
Alarm	High Compressor 2 Last Runtime				12/16/2019, 1:31:16 PM
Info	Alarms Reset				12/16/2019, 1:31:15 PM
Alarm	High Compressor 2 Last Runtime				12/16/2019, 1:30:36 PM
Alarm	High Compressor 1 Last Runtime				12/16/2019, 1:30:36 PM
Alarm	Low Outlet Pressure				12/16/2019, 1:30:36 PM
Info	Alarms Reset				12/16/2019, 1:30:35 PM
Alarm	High Compressor 2 Last Runtime				12/16/2019, 1:30:35 PM
Alarm	High Compressor 1 Last Runtime				12/16/2019, 1:30:35 PM
Alarm	Low Outlet Pressure				12/16/2019, 1:30:35 PM
Info	Alarms Reset				12/16/2019, 1:30:34 PM
Alarm	High Compressor 1 Last Runtime				12/16/2019, 1:30:34 PM
Alarm	High Compressor 2 Last Runtime				12/16/2019, 1:30:33 PM
	Low Outlet Pressure				

Displays all events such as alarms, changes made, and alarm resets registered by the BD8400W Series Air-dryer. This screen is informational only. You may download a .csv file with all event/alarm information by clicking on the “Download CSV” button at the top right hand corner of the table.

8.20 Using the Firmware Screen

Status	Setup	Events/Alarms	Firmware						
<table border="1"><tr><td>Current Version:</td><td>Firmware Version: 0.1.2</td><td>Library Version: 0.1.0</td></tr><tr><td>New Version File:</td><td><input type="button" value="Browse..."/></td><td>No file selected.</td></tr></table>				Current Version:	Firmware Version: 0.1.2	Library Version: 0.1.0	New Version File:	<input type="button" value="Browse..."/>	No file selected.
Current Version:	Firmware Version: 0.1.2	Library Version: 0.1.0							
New Version File:	<input type="button" value="Browse..."/>	No file selected.							
<input type="button" value="ACCEPT"/>									

Displays the current firmware version and date of the BD8400W Series Air-dryer.

- **Current Version:** Displays the current firmware version of the BD8400W Series Air-dryer.
- **New Version File:** Displays the new location and new firmware version chosen.
- The **BROWSE** Button allows you to locate the new firmware file.
- The **ACCEPT** Button is used to change values.
- Keyword validation is required to update firmware.

8.21 Connecting via SNMP

Using SNMP to connect and communicate with the BD8400 Series Air-dryer is dependent upon the specific SNMP Management software used on your network. This software requires a SNMP Definition & Configuration File (MIB file) in order to properly communicate with the Air-dryer.

The files for the BD8400 Series Air-dryers can be downloaded from our website (AltecAir.com) under the Product Support section SNMP Files link. It is necessary to import this file into your SNMP operating software.

9. Testing Your Dryer

NOTE: Many of the procedures described in this section will be easier with both System 1 and System 2 operating. It is recommended that you change the System Cycle Mode to **BOTH** for the following procedures

9.1 Safety & Warning Information



WARNING!

Extreme care should be exercised to avoid contact with live electrical circuits. Many procedures performed during installation, operation, testing, and maintenance of this air-dryer require the equipment to be running, creating a situation for potential electrical shock. It is highly recommended that you remove all jewelry before performing any procedures.



WARNING!

Internal surfaces may be hot. Use care when coming into contact with internal components as there is a potential for some of these components to become hot when in operation or standby.



WARNING!

High Noise. RFS air-dryers are meant to be installed in an unattended area.



CAUTION!

Observe precautions for handling **Electrostatic Sensitive Devices.**



CAUTION!

Depressurizing the air-dryer may be necessary before performing certain procedures. **NEVER** remove pressure sensing tubes from the control board without depressurizing the air-dryer first, or **damage to the control board will occur.**

9.2 Measuring Compressor Amp Draw



WARNING!

Internal surfaces may be hot. Use care when coming into contact with internal components as there is a potential for some these components to become hot when in operation or standby.

With the Compressor running:

9.2.1 Remove Front Panel (see section 8.10.2)

9.2.2 Locate the hot lead wire going to the Compressor you will be measuring:

System 1 = **Wire #1**

System 2 = **Wire #8**

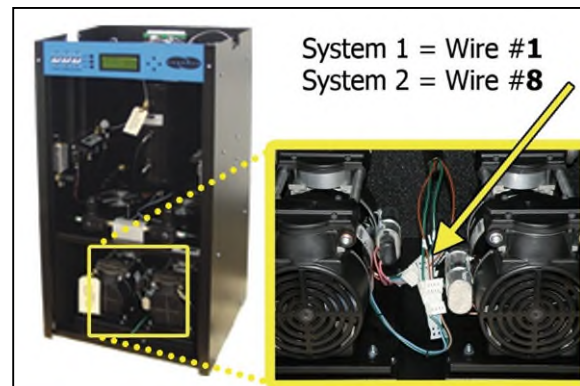

9.2.3 Use an Amp Meter to measure the running amps.

With the compressor running, the running amps should measure **4.0 amps or below**.



9.2.4 Reinstall Front Panel.

If the compressor measures over 4.0 running amps, see section 13.15 for troubleshooting information.

9.3 Measuring Voltage to Compressor



WARNING!

Extreme care should be exercised to avoid contact with live electrical circuits. It is highly recommended that you remove all jewelry before performing any procedures.

9.3.1 Remove Front Panel (see section 8.10.2)

With the Compressor running:

9.3.2 Locate the power lead wires to the compressor to be measured.

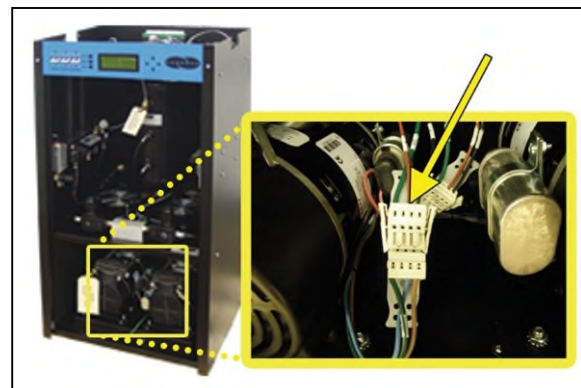

9.3.3 Use a Voltmeter to measure the voltage between the Hot and Neutral wires by placing the probes in the openings in the power connector:

System 1 = **Wires #1 & #2**

System 2 = **Wires #8 & #7**

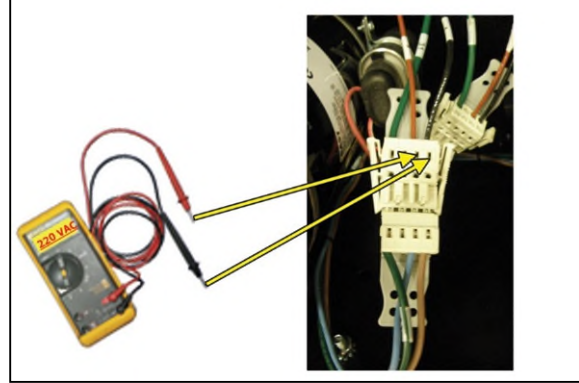

The voltage should measure **210 - 230 VAC**.

9.3.4 Reinstall Front Panel.

9.4 Measuring Incoming Voltage



WARNING!

Extreme care should be exercised to avoid contact with live electrical circuits. It is highly recommended that you remove all jewelry before performing any procedures.

9.4.1 Remove Top Cover (see section 8.10.1)

9.4.2 Locate the Main POWER
Circuit Breaker.

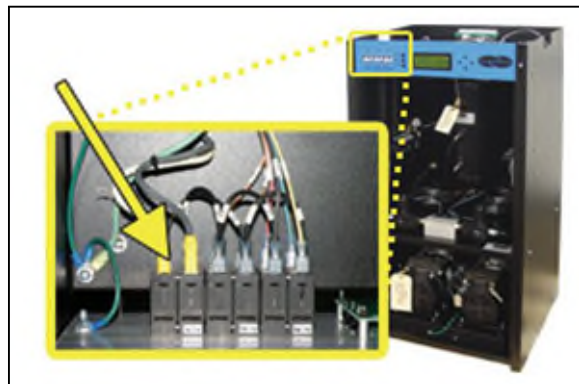

9.4.3 Place Voltmeter probes between the Circuit Breaker and terminal insulation so that they touch the metal contacts.

The voltage should measure **210 - 230 VAC**.

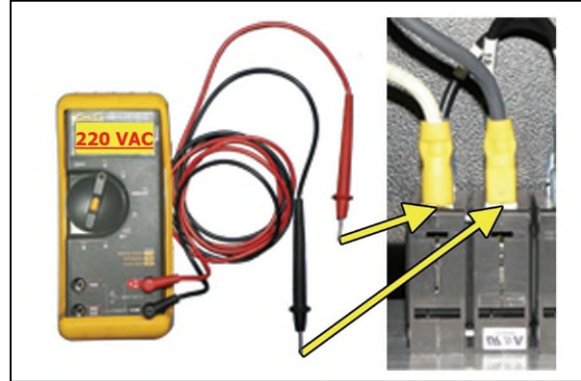

9.4.4 Reinstall Top Cover.

If the incoming voltage measures less than 210 VAC, it is necessary to engage the Boost Transformer in order to increase the voltage to the desired range of 210-230 VAC. See section 8.15 for procedure.

9.5 Measuring Voltages at Solid State Relay

9.5.1 Remove Top Cover (see section 8.10.1)

9.5.2 Locate the Solid State Relay for the system you will be testing:

- Left – System 1
- Right – System 2

(System = System 1 or System 2)*

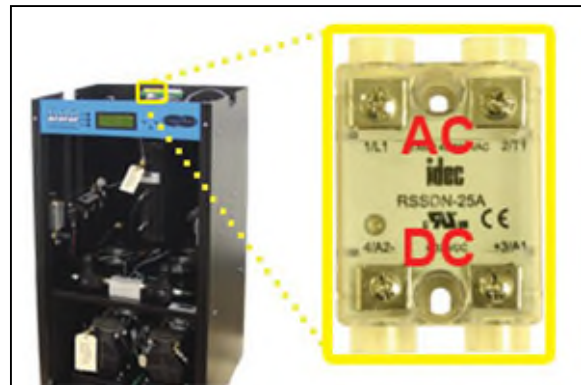

With the System* Compressor running:

9.5.3 Use a Voltmeter to measure across the AC terminals.
Should measure **0 VAC**.

9.5.4 Use a Voltmeter to measure across the DC terminals.
Should measure **12 VDC**.

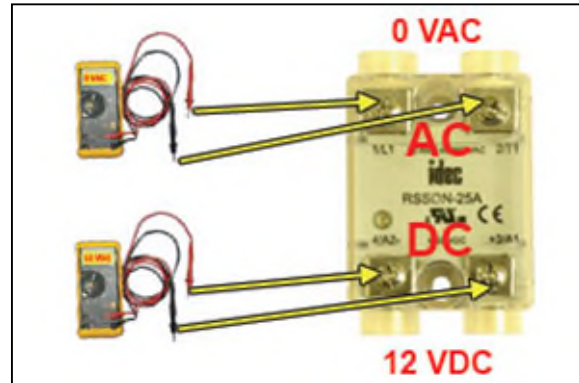
**With the System* Compressor NOT running:**

9.5.5 Use a Voltmeter to measure across the AC terminals.
Should measure **210 - 230 VAC**.

9.5.6 Use a Voltmeter to measure across the DC terminals.
Should measure **0 VDC**.

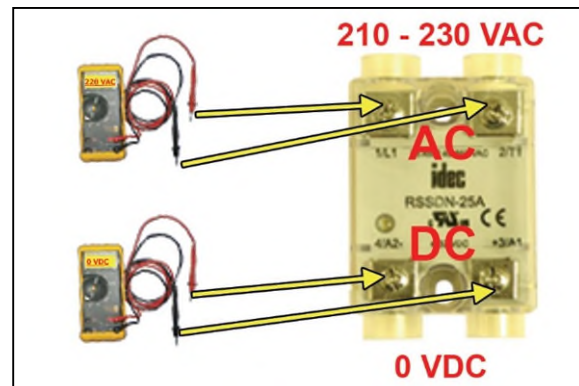

9.5.7 Reinstall Top Cover.

If any of the voltage measurements are different than indicated above, the Solid State Relay is defective and should be replaced. See sections 11.1 for part detail and 11.7 for ordering information.

9.6 Testing Consistent Heatless Dryer Cycling

With the System* Compressor running (*System* = System 1 or System 2*):

9.6.1 Remove Front Panel (see section 8.10.2)

9.6.2 Disconnect the purge tubes from the System* Heatless Dryer.

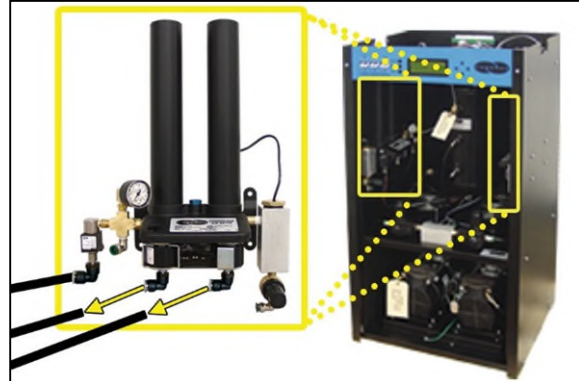

9.6.3 Place your hand beneath the purge fittings to feel for purging air. Air should:

- Purge from Tower 1 side
- Purge from Tower 2 side
30 Seconds later
- Purge from Tower 1 side
30 Seconds later
- ...and so on.

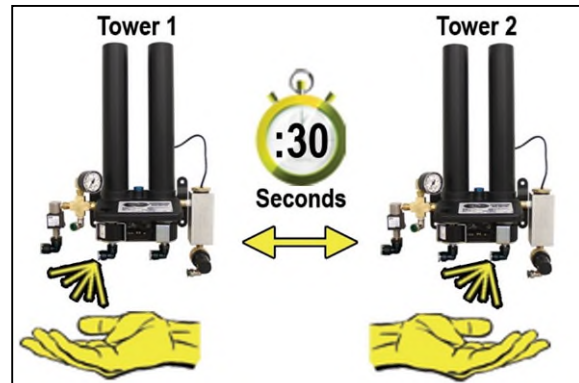

9.6.4 Re-connect the purge tubes to the Heatless Dryer.

9.6.5 Reinstall Front Panel.



If the Heatless Dryer is not cycling consistently as described, see section 13.20 for troubleshooting information.

9.7 Testing Unloader Valve

With the System* Compressor running (*System* = System 1 or System 2*):

9.7.1 Remove Front Panel (see section 8.10.2)

9.7.2 Disconnect the unloader tube from the System* Unloader Valve.

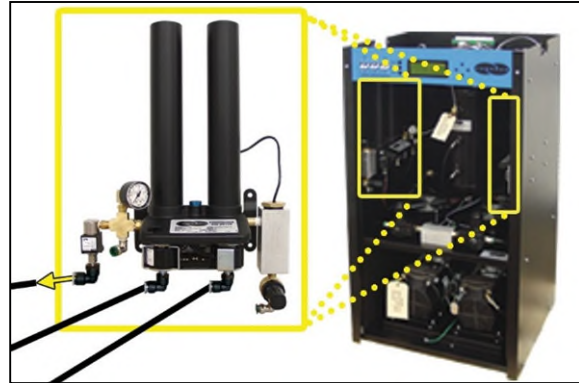

9.7.3 Place your hand beneath the Unloader Valve fitting to feel for air flow.

Air should **NOT** flow from this fitting continuously. Air should only be released in a short burst when the System* compressor shuts off.

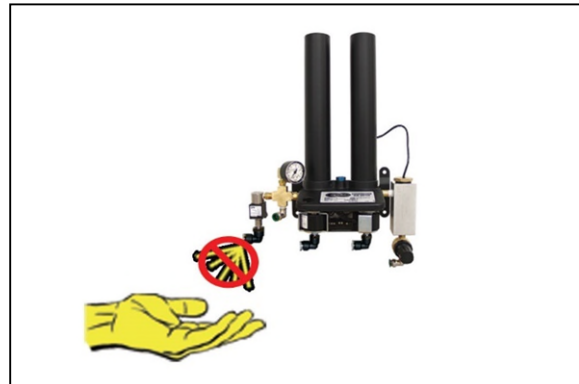

9.7.4 Re-connect the unloader tube to the Unloader Valve.

9.7.5 Reinstall Front Panel.



If air flows from this valve continuously the Unloader Valve is defective and should be replaced. See sections 11.3 for part detail and 11.7 for ordering information.

9.8 Measuring Heatless Dryer Solenoid Voltage

With the System* Compressor running (*System** = *System 1* or *System 2*):

9.8.1 Remove Front Panel (see section 8.10.2)

9.8.2 Locate the Heatless Dryer
Cycle Timer.

The timer has three (3) sets of
terminals (from left-to-right):
“**106VDC**” – Left solenoid
“**IN**” – Incoming power
“**106VDC**” – Right solenoid

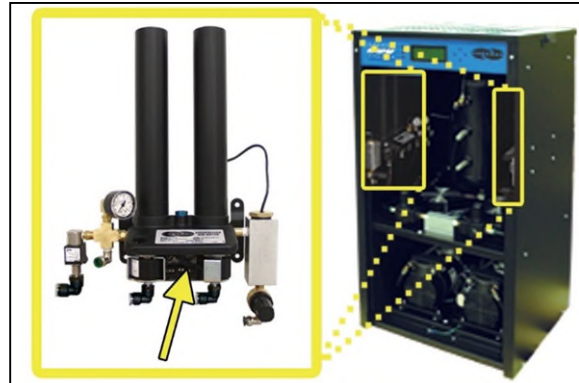

9.8.3 Use a Voltmeter to measure
the DC voltage across each
set of “**106VDC**” terminals.

Continue to measure for up to 45
seconds if no voltage is initially
measured.

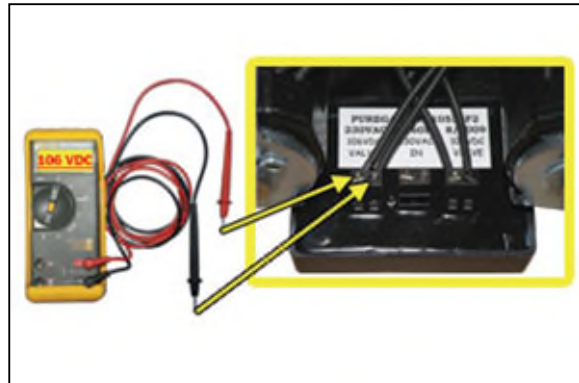

The voltage should measure **106 Volts DC**.

9.8.4 Reinstall Front Panel.

If the voltage does not measure 106 Volts DC, this is an indication that the Cycle Timer is defective and should be replaced. See sections 11.3 for part detail and 11.7 for ordering information.

9.9 Testing Precooler Fans

9.9.1 Remove Front Panel (see section 8.10.2)

9.9.2 Place your hand above the Precooler Fan(s) to feel for air being blown upwards.

9.9.3 Reinstall Front panel.

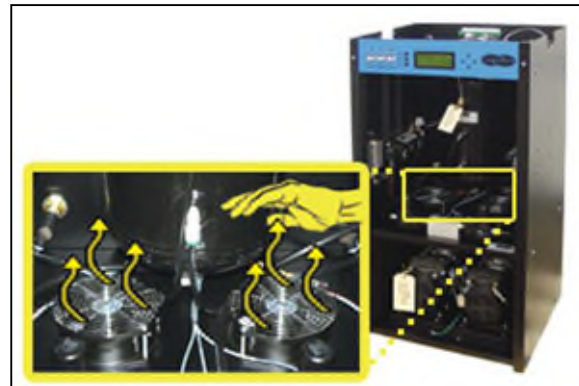

If either fan is not blowing air upwards as described:

- Check for loose wiring. Refer to the Wiring Diagram (section 14.1)
- Replace defective fan (see sections 11.2 for part detail and 11.7 for ordering information).

9.10 Testing Safety Relief Valve

9.10.1 Remove Front Panel (see section 8.10.2)

9.10.2 Pull the ring handle on the Safety Relief Valve to verify air pressure is released.

9.10.3 Release ring handle and verify that no air is leaking from the valve.

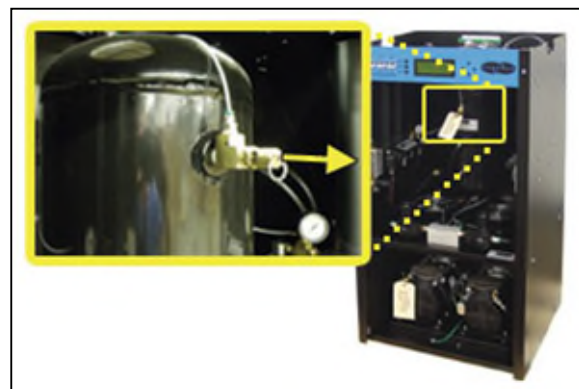

9.10.4 Reinstall Front Panel.

If the Safety Relief Valve fails either test described, it must be replaced. See sections 11.2 for part detail and 11.7 for ordering information.

9.11 Testing Compressor ON/OFF Cycling

9.11.1 Remove Front Panel (see section 8.10.2)

9.11.2 When the Unit Screen (8.4.5.1) appears on the display, press the **HOLD Button** on the Front Panel to freeze that screen.



With Compressor(s) running:

9.11.3 Verify the compressor(s) shuts down when the tank pressure (**TANK**) reaches **50.0 PSI**.

*If the tank pressure (**TANK**) fails to reach 50 PSI, see section 13.14 for troubleshooting information.*

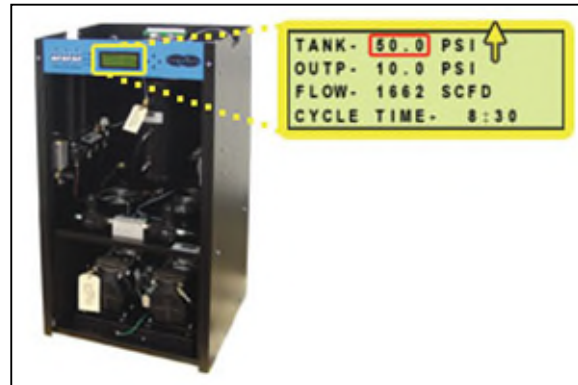

With Compressor(s) NOT running:

9.11.4 Pull the ring handle on the Safety Relief Valve to release air pressure from the air tank.

9.11.5 Verify the compressor(s) turns on when the tank pressure (**TANK**) falls to **20.0 PSI**.

9.11.6 Reinstall Front Panel.

If the Compressor Cycling fails either test described, it indicates a problem with the Control Board which may need to be replaced. See sections 11.1 for part detail and 11.7 for ordering information.



9.12 Testing Compressor Excessive Run Time Alarms

NOTE: All testing values are based on default Air-dryer settings, if settings have been changed, adjust testing values accordingly. Reference the Appendix Section 14.2 for Limits and Defaults.

NOTE: For this test, allow the Display Screen to cycle through the information screens.

9.12.1 Remove Front Panel (see section 8.10.2)

9.12.2 Start timing when the compressor(s) turns on.

9.12.3 Pull the ring handle on the Safety Relief Valve (when necessary) to keep the Tank Pressure (**TANK**) from reaching **50 PSI**.
This prevents the compressor(s) from shutting down.



When the compressor(s) runs for 3:00 minutes (unless adjusted to a different Set Point by the user), a Compressor Excessive Run Time (**LAST RUN**) alarm should appear on one or both of the System screens.

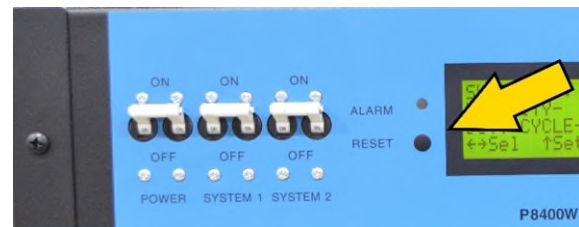

9.12.4 Press the **RESET Button** to clear the alarm.

9.12.5 Reinstall Front Panel.

*If you are unable to create a Compressor Excessive Run Time (**LAST RUN**) alarm as described, see section 13.18 for troubleshooting information.*

9.13 Testing Humidity Alarm and System Shutdown

NOTE: For this test, make sure the air-dryer is operating in **BOTH** Cycle Mode (see section for details on changing Cycle Mode).

Test one System at a time (*System** = *System 1* or *System 2*).

9.13.1 Remove Front Panel (see section 8.10.2)

9.13.2 Turn the System* Circuit Breaker **OFF**.

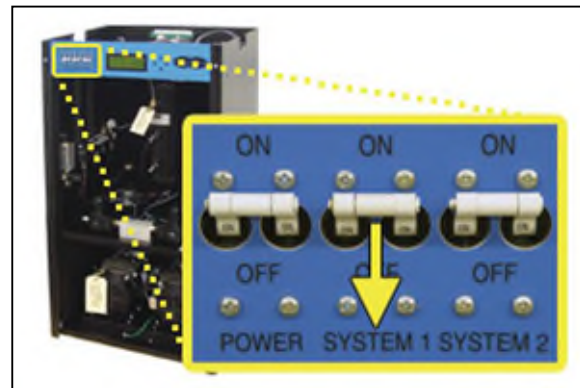

9.13.3 When the System* Screen (8.4.5.3) appears on the display, press the **HOLD** Button on the Front Panel to freeze that screen.



9.13.4 Verify the System* pressure is zero (0).

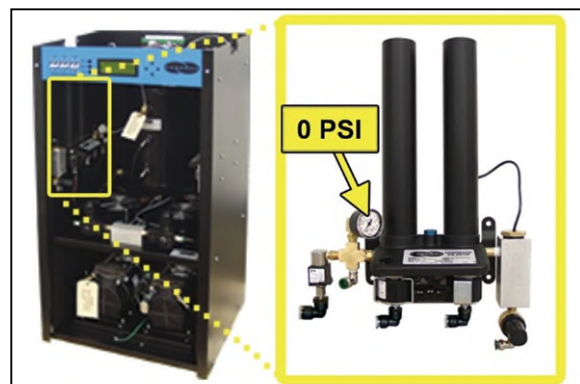

- 9.13.5** Unscrew and remove the Humitter from the Humidity Block.



- 9.13.6** Allow the Humidity reading to rise over 10.0%.

- 9.13.7** After three (3) minutes, verify that a Humidity Alarm appears and System* goes into **SHUTDOWN** mode.

- 9.13.8** Replace the Humitter into the Humidity Block.



- 9.13.9** Reinstall Front Panel.

- 9.13.10** Turn the System* Circuit Breaker **ON**.

- 9.13.11** Press the **RESET Button** to clear the alarm.

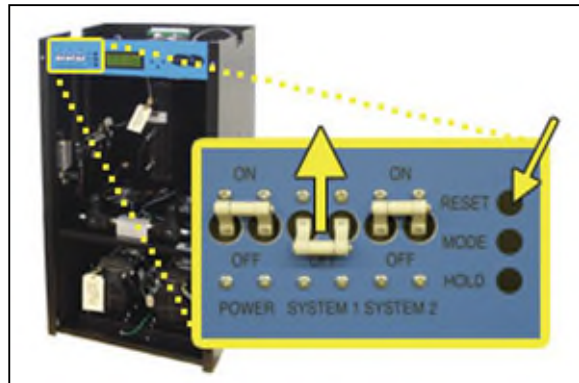

If you are unable to create a Humidity / Shutdown alarm as described, see section 13.12 for troubleshooting information.

9.14 Testing High Outlet Pressure Alarm

9.14.1 Remove Front Panel (see section 8.10.2)

9.14.2 When the Unit Screen (8.4.5.1) appears on the display, press the **HOLD Button** on the Front Panel to freeze that screen.



9.14.3 Make a note of the current Outlet Pressure (**OUTP**) reading.

With Compressor(s) running:

9.14.4 Pull the Outlet Pressure Regulator knob out.

9.14.5 Turn knob clockwise until Outlet Pressure (**OUTP**) reading climbs **over 12.0 PSI**.



After one (1) minute, the High Pressure Alarm should appear on the display.

9.14.6 Turn Outlet Pressure Regulator knob counter-clockwise until Outlet Pressure (**OUTP**) reading lowers to the reading recorded in step 9.14.3

9.14.7 Push knob in to lock.



9.14.8 Press the **RESET Button** to clear the alarm.

9.14.9 Reinstall Front Panel.

If you are unable to create a High Outlet Pressure Alarm as described, see section 13.6 for troubleshooting information.

9.15 Testing Low Outlet Pressure Alarm

9.15.1 Remove Front Panel (see section 8.10.2)

9.15.2 When the Unit Screen (8.4.5.1) appears on the display, press the **HOLD Button** on the Front Panel to freeze that screen.



9.15.3 Make a note of the current Outlet Pressure (**OUTP**) reading.

With Compressor(s) running:

9.15.4 Pull the Outlet Pressure Regulator knob out.

9.15.5 Turn knob counter-clockwise until Outlet Pressure (**OUTP**) reading drops **below 6.5 PSI**.

After one (1) minute, the Low Pressure Alarm should appear on the display.

9.15.6 Turn Outlet Pressure Regulator knob clockwise until Outlet Pressure (**OUTP**) reading raises to the reading recorded in step 9.15.3



9.15.7 Push knob in to lock.

9.15.8 Press the **RESET Button** to clear the alarm.

9.15.9 Reinstall Front Panel.

If you are unable to create a Low Outlet Pressure Alarm as described, see section 13.8 for troubleshooting information.

9.16 Testing Air Fittings & Hoses for Leaks

NOTE: This is a general procedure that can be applied to any fitting or hose that has air pressure in it. **DO NOT SOAP TEST THE HUMITTER FITTING. DAMAGE TO THE HUMITTER MAY OCCUR.**

With Compressor(s) NOT running:

9.16.1 Listen for any 'hissing' sounds which may indicate a fitting or hose air leak.

With Compressor(s) running:

9.16.2 Use a 1-inch paint brush to dab soapy water on the air fitting or hose connection to be tested.

If air bubbles appear at the connection, this indicates that air is leaking from the connection.

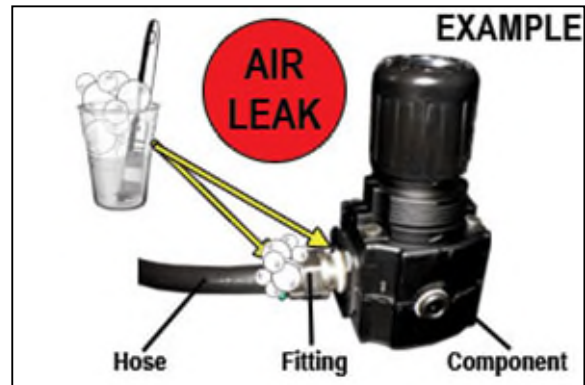

If any leaks are detected, take steps to seal them off (as necessary):

- *Tighten the fitting*
- *Re-connect the hose end*
- *Replace the fitting / hose / component*

10. Maintaining Your Dryer

In order to ensure that your BD8400W Air-dryer continues to operate efficiently and reliably, RFS recommends performing the following maintenance procedures at the specified Six Month / 8,000 Hour / and 16,000 Hour intervals.

It is also recommended that you print out the included *Six Month Maintenance (section 10.2)* and *8,000 & 16,000 Hour Maintenance (section 10.3)* log sheets and record all completed maintenance for historical tracking and reference purposes.

The log sheets include a Section reference column which indicates the User's Guide section containing the information about the specific procedure. Please refer to these sections for detailed procedural information.

NOTE: When operating at higher ambient temperatures, it is recommended that maintenance be performed more frequently.

NOTE: After 16,000 hours of run time, RFS recommends sending in your compressors and heatless dryers for a complete and comprehensive rebuild by our Service Department technicians. *See sections 12.1 and 12.2 for information on services and contacting RFS.*

10.1 Safety & Warning Information



WARNING!

Extreme care should be exercised to avoid contact with live electrical circuits. Many procedures performed during installation, operation, testing, and maintenance of this air-dryer require the equipment to be running, creating a situation for potential electrical shock. It is highly recommended that you remove all jewelry before performing any procedures.

**WARNING!**

Internal surfaces may be hot. Use care when coming into contact with internal components as there is a potential for some of these components to become hot when in operation or standby.

**CAUTION!**

SHUT DOWN IMMEDIATELY FOR REPAIRS if the air compressor(s) shows any evidence of overheating or presents excessive noise.

**CAUTION!**

Depressurizing the air-dryer may be necessary before performing certain procedures. **NEVER** remove pressure sensing tubes from the Control Board without depressurizing the air-dryer first, or **damage to the Control Board will occur.**

**WARNING!**

High Noise. Puregas air-dryers are meant to be installed in an unattended area.

**CAUTION!**

Observe precautions for handling **Electrostatic Sensitive Devices.**

**IMPORTANT!**

After performing any maintenance, always soap test pressure fittings to check for air leaks. Also, check for any loose or disconnected wiring.

10.2 Six Month Maintenance

MODEL: **BD8400W** _____

LOCATION NAME: _____

SERIAL NUMBER: _____

ADDRESS: _____

DATE INSTALLED: _____

Procedure	Section	Maintenance Interval (Months)				
		6	12	18	24	30
Install Six Month Maintenance Kit P011766	11.6	<input type="checkbox"/>	<input type="checkbox"/>	<input type="checkbox"/>	<input type="checkbox"/>	<input type="checkbox"/>
Read & Record Flow Rate (FLOW)	8.4.5.1					
Measure & Record Compressor 1 Amp Draw	9.2					
Measure & Record Compressor 2 Amp Draw	9.2					
Measure & Record Incoming Voltage (must be 210 - 230 VAC)	9.4					
Test High & Low Outlet Pressure Alarms	9.14 & 9.15	<input type="checkbox"/>	<input type="checkbox"/>	<input type="checkbox"/>	<input type="checkbox"/>	<input type="checkbox"/>
Set System Pressure (50 PSI)	8.12	<input type="checkbox"/>	<input type="checkbox"/>	<input type="checkbox"/>	<input type="checkbox"/>	<input type="checkbox"/>
Set Static Pressure (17 PSI)	8.13	<input type="checkbox"/>	<input type="checkbox"/>	<input type="checkbox"/>	<input type="checkbox"/>	<input type="checkbox"/>
Set Outlet Pressure	8.14	<input type="checkbox"/>	<input type="checkbox"/>	<input type="checkbox"/>	<input type="checkbox"/>	<input type="checkbox"/>
Test Consistent Heatless Dryer Cycling	9.6	<input type="checkbox"/>	<input type="checkbox"/>	<input type="checkbox"/>	<input type="checkbox"/>	<input type="checkbox"/>
Test Precooler Fans	9.9	<input type="checkbox"/>	<input type="checkbox"/>	<input type="checkbox"/>	<input type="checkbox"/>	<input type="checkbox"/>
Test Safety Relief Valve	9.10	<input type="checkbox"/>	<input type="checkbox"/>	<input type="checkbox"/>	<input type="checkbox"/>	<input type="checkbox"/>
Test Compressor ON/OFF Cycling	9.11	<input type="checkbox"/>	<input type="checkbox"/>	<input type="checkbox"/>	<input type="checkbox"/>	<input type="checkbox"/>
Test Compressor Excessive Run Time Alarms	9.12	<input type="checkbox"/>	<input type="checkbox"/>	<input type="checkbox"/>	<input type="checkbox"/>	<input type="checkbox"/>
Test Humidity Alarm & System Shutdown	9.13	<input type="checkbox"/>	<input type="checkbox"/>	<input type="checkbox"/>	<input type="checkbox"/>	<input type="checkbox"/>
Test Air Fittings for Leaks	9.16	<input type="checkbox"/>	<input type="checkbox"/>	<input type="checkbox"/>	<input type="checkbox"/>	<input type="checkbox"/>
Clean Precooler Coils		<input type="checkbox"/>	<input type="checkbox"/>	<input type="checkbox"/>	<input type="checkbox"/>	<input type="checkbox"/>
Visually Inspect Inside & Outside of Unit for Loose Wiring or Hardware		<input type="checkbox"/>	<input type="checkbox"/>	<input type="checkbox"/>	<input type="checkbox"/>	<input type="checkbox"/>
Maintenance Performed by:						
Date of Maintenance:						

NOTE: COPY OR PRINT THIS PAGE AND KEEP IT WITH THE AIR-DRYER

10.3 8,000 & 16,000 Hour Maintenance

Under typical operating conditions:

8,000 hours of run time will occur between one (1) and two (2) years of use.

16,000 hours of run time will occur between two (2) and three (3) years of use.

This will be identified by a Compressor Total Hour Alarm on the display for either System 1 or System 2 (*section 8.5.9*).

MODEL: **BD8400W** _____

LOCATION NAME: _____

SERIAL NUMBER: _____

ADDRESS: _____

DATE INSTALLED: _____

Procedure	Section	Maintenance Interval (Hours)				
		8,000	16,000	24,000	32,000	40,000
Install 8,000 Hour Maintenance Kit P011813	11.6	<input type="checkbox"/>		<input type="checkbox"/>		<input type="checkbox"/>
Install 16,000 Hour Maintenance Kit P011814	11.6		<input type="checkbox"/>		<input type="checkbox"/>	
Read & Record Flow Rate (FLOW)	8.4.5.1					
Measure & Record Compressor 1 Amp Draw	9.2					
Measure & Record Compressor 2 Amp Draw	9.2					
Set System Pressure (50 PSI)	8.12	<input type="checkbox"/>	<input type="checkbox"/>	<input type="checkbox"/>	<input type="checkbox"/>	<input type="checkbox"/>
Set Static Pressure (17 PSI)	8.13	<input type="checkbox"/>	<input type="checkbox"/>	<input type="checkbox"/>	<input type="checkbox"/>	<input type="checkbox"/>
Set Outlet Pressure	8.14	<input type="checkbox"/>	<input type="checkbox"/>	<input type="checkbox"/>	<input type="checkbox"/>	<input type="checkbox"/>
Test Consistent Heatless Dryer Cycling	9.6	<input type="checkbox"/>	<input type="checkbox"/>	<input type="checkbox"/>	<input type="checkbox"/>	<input type="checkbox"/>
Test Compressor ON/OFF Cycling	9.11	<input type="checkbox"/>	<input type="checkbox"/>	<input type="checkbox"/>	<input type="checkbox"/>	<input type="checkbox"/>
Test Air Fittings for Leaks	9.16	<input type="checkbox"/>	<input type="checkbox"/>	<input type="checkbox"/>	<input type="checkbox"/>	<input type="checkbox"/>
Reset Total Hour Readings to Zero System 1 & System 2		<input type="checkbox"/>	<input type="checkbox"/>	<input type="checkbox"/>	<input type="checkbox"/>	<input type="checkbox"/>
Visually Inspect Inside & Outside of Unit for Loose Wiring or Hardware		<input type="checkbox"/>	<input type="checkbox"/>	<input type="checkbox"/>	<input type="checkbox"/>	<input type="checkbox"/>
Maintenance Performed by:						
Date of Maintenance:						

NOTE: COPY OR PRINT THIS PAGE AND KEEP IT WITH THE AIR-DRYER

11. Replacement Parts & Accessories

11.1 Top Section Parts

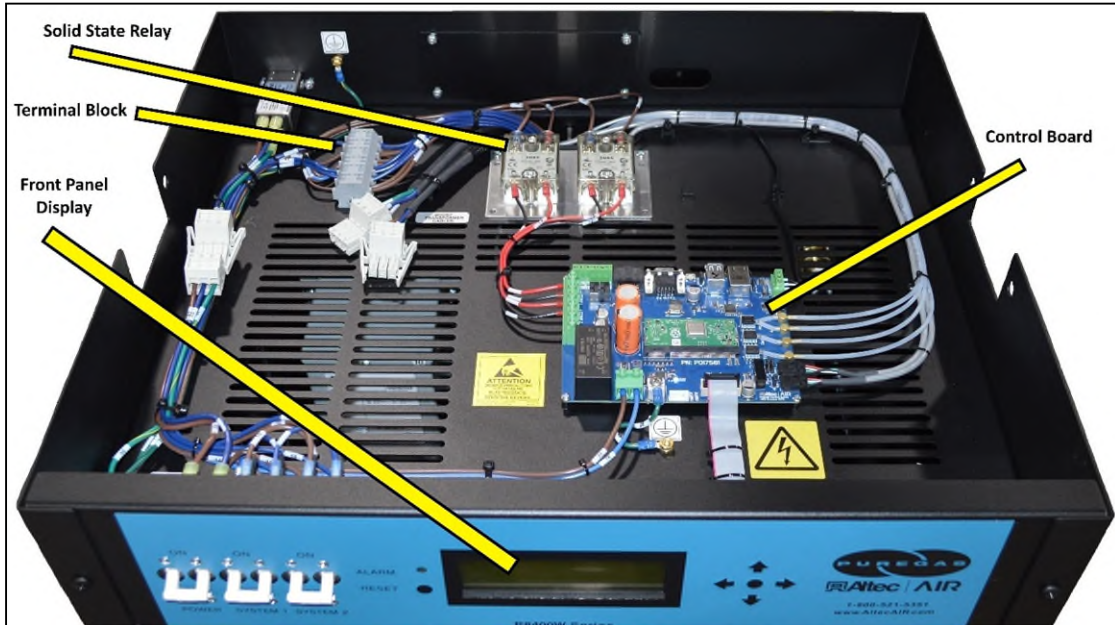

Description	Part Number	Quantity	Recommend Spare
Solid State Relay	P010562	2	✓ (1)
Terminal Block	P010200	1	
Front Panel Display Assembly	P017578	1	
LCD Display Only	P012105	1	
Circuit Breaker	P010563	3	✓ (1)
Cabinet Temperature Sensor	On PCB	1	
Control Board	P017581-RFS	1	✓ (1)

11.2 Middle Section Parts

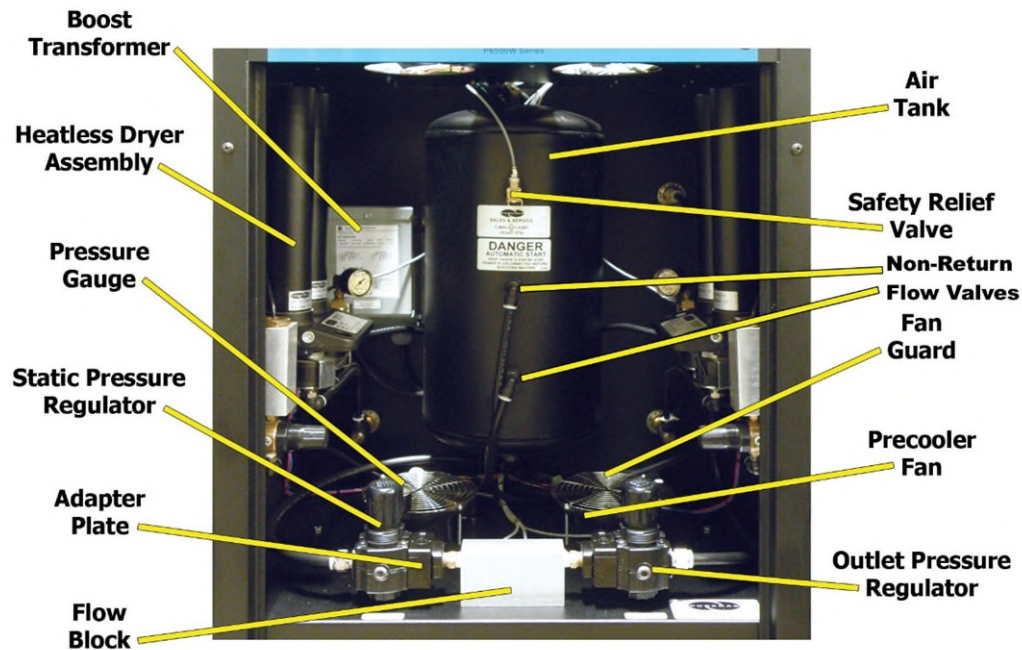

Description	Part Number	Quantity	Recommend Spare
Boost Transformer	P012772	1	
Heatless Dryer Assembly	<i>See section 11.3 for detail.</i>		
Pressure Gauge (0-30 PSI)	P011339	1	
Static Pressure Regulator	P013203	1	✓ (1)
Adapter Plate		2	
Flow Block		1	
Air Tank		1	
Non-Return Flow Valves		2	
Safety Relief Valve	P03646	1	
Fan Guard		2	
Precooler Fan	P010496	2	✓ (1)
Outlet Pressure Regulator	P013203	1	✓ (1)

11.3 Heatless Dryer Assembly Parts

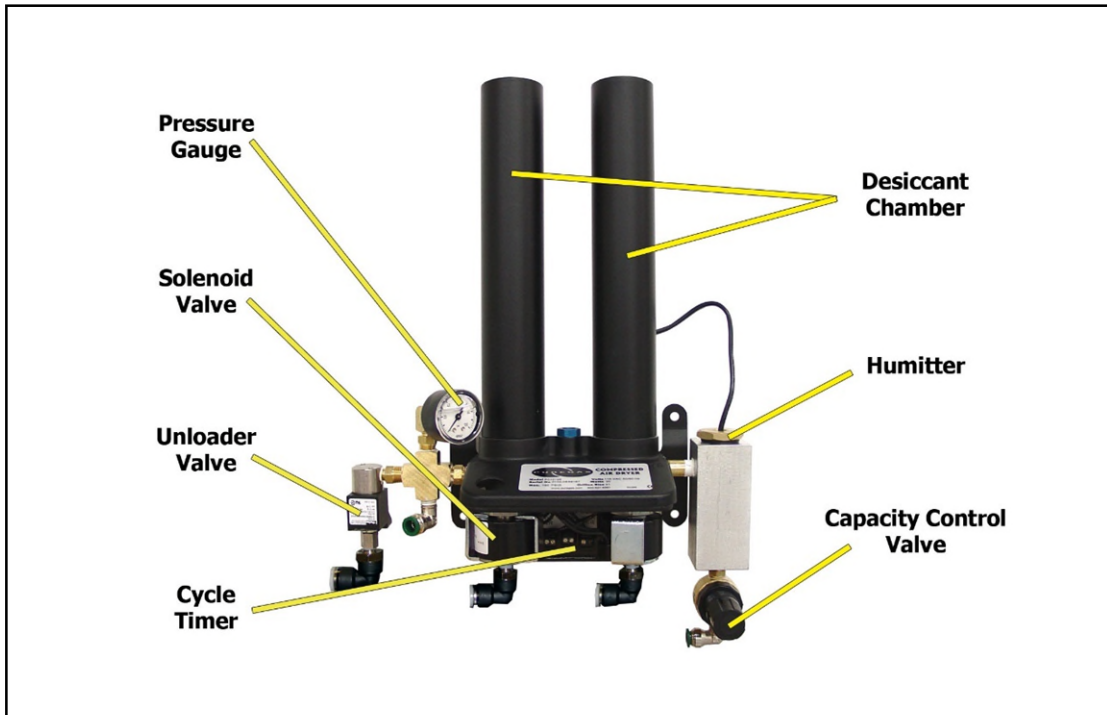

Description	Part Number	Quantity	Recommend Spare
Heatless Dryer	P010196	1	
Pressure Gauge	P010695	1	
Solenoid Valve	<i>In Kit P011813. See section 11.6 for detail.</i>		
Unloader Valve	P010453	1	
Cycle Timer	P010490	1	
Desiccant Chamber	P20040312	2	
Humitter	P013401	1	✓ (1)
Capacity Control Valve	P010492	1	✓ (1)

11.4 Lower Section Parts

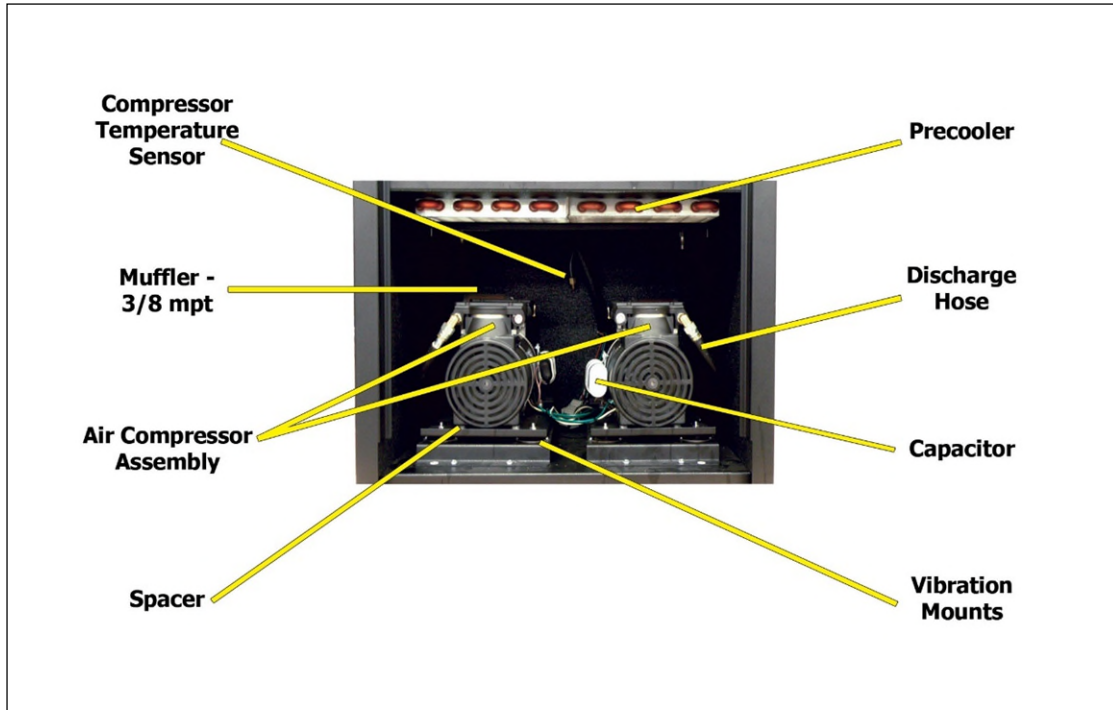

Description	Part Number	Quantity	Recommend Spare
Compressor Temperature Sensor	P017647	1	
Muffler – 3/8 NPT	<i>In Kit P011766. See section 11.6 for detail.</i>		
Air Compressor Assembly*			
Left Side	P013263		✓ (1)
Right Side	P013264		✓ (1)
Compressor ONLY	P010444	1	✓ (1)
Spacer		8	
Precooler	P05663	2	
Discharge Hose	P05069	2	
Capacitor		2	
Vibration Mount	P010494	8	✓ (8)



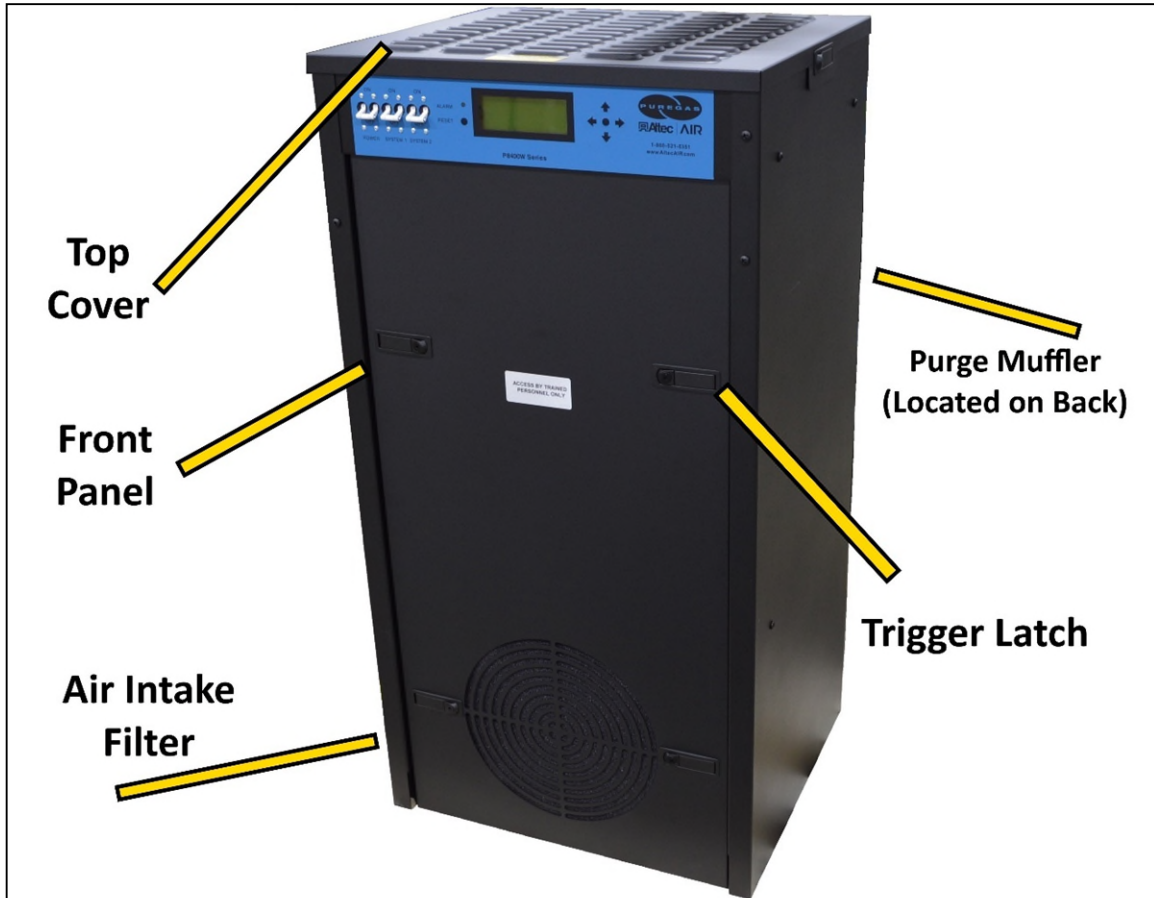

*Assembled for quick, easy installation. Includes: compressor, bracket, mounting plate, vibration mounts, spacers, fittings, electrical connectors, and air intake filter/muffler.

11.5 Frame Section Parts



Description	Part Number	Quantity	Recommend Spare
Top Cover		1	
Front Panel		1	
Air Intake Filter	<i>In Kit P011766. See section 11.6 for detail.</i>		
Purge Muffler	<i>In Kit P011766. See section 11.6 for detail.</i>		
Locking Trigger Latch		6	

11.6 Accessories for Your Dryer

	Description	Part Number	Recommend Spare
	<p>Installation Kit Includes fittings required to connect to 3/4" flexible hose.</p>	P011752	
	<p>Six Month Maintenance Kit Includes air intake filter, compressor mufflers, and purge mufflers.</p>	P011766	✓ (2)
	<p>8,000 Hour Maintenance Kit Includes heatless dryer maintenance kits and compressor maintenance kits.</p>	P011813	✓ (1)
	<p>16,000 Hour Maintenance Kit Includes heatless dryer maintenance kits, compressor maintenance kits.</p>	P011814	✓ (1)
	<p>Monitoring Interface Allows the dryer to be fully monitored by Altec AIR monitoring systems.</p>	RJ11 cable(s)	

11.7 Ordering Parts from Altec AIR



IMPORTANT!

Instruction for the replacement of individual listed components goes beyond the scope of this User's Guide and will not be covered. Please refer to the information included with the specific replacement part for this instruction.

Once you have identified your required parts and accessories, contact the Altec AIR Inside Sales / Service department to order:

(800) 521-5351 (**option 2**)

Fax – (303) 657-2205

sales@AltecAIR.com

parts@AltecAIR.com

12. Service & Repair

Only RFS can offer factory direct rebuilds backed by a 6 month factory warranty.

- 2 week turnaround time
- Estimates available upon request
- Minimum service charge fee applies

12.1 Services Offered

- **Piston Compressor Rebuild**
 - Replace motor bearings, piston rod assemblies, and install a complete compressor maintenance kit.
 - Test air flow, air pressure, and electrical performance
- **Heatless Dryer Rebuild**
 - Replace desiccant, o-rings, check valves, springs, and complete solenoid assembly
 - Test proper component operation
- **Desiccant Tower Repack**
 - Clean out tower and replace desiccant, filter, and o-ring
- **Circuit Board Repair** (Limited to current model boards only)
- **Complete Dryer Repair**

12.2 Initiating a Service Transaction

- Contact our Parts & Service Department at **1-800-521-5351 (option 3)** to obtain a Return Authorization (RA) number.
- Carefully package the item(s) to be returned.
- Mark the Return Authorization (RA) number on the outside of the shipping container.
- Include the main address and phone number of the individual to contact for related inquiry and follow-up information.
- Include the purchase order number.

13. Troubleshooting Your Dryer

13.1 Before You Call Altec AIR

PLEASE READ THIS SECTION FIRST. It is important that you use the following sections in order to diagnose and attempt to fix the problem with your air-dryer before placing a call to Altec AIR Technical Support.

This troubleshooting guide is intended to simplify the isolation of problems, present possible causes, provide test procedures for verification, and suggest corrective actions to restore the air-dryer back to normal operation. Each section begins with the most likely cause(s) of the issue. Otherwise, they start from the simplest possibilities and progress to more complicated ones.

This troubleshooting guide is designed to be easy to follow and very effective when used properly. It is suggested to always start at the beginning of the specific problem section and continue in sequence, following the procedures indicated.

13.2 Safety & Warning Information



WARNING!

For your safety, all the information in this User's Guide must be followed to minimize the risk of electrical shock, and prevent property damage or personal injury.



WARNING!

Internal surfaces may be hot. Use care when coming into contact with internal components as there is a potential for some of these components to become hot when in operation or standby.

**WARNING!**

Extreme care should be exercised to avoid contact with live electrical circuits. Many procedures performed during installation, operation, testing, and maintenance of this air-dryer require the equipment to be running, creating a situation for potential electrical shock. It is highly recommended that you remove all jewelry before performing any procedures.

**CAUTION!**

Depressurizing the air-dryer may be necessary before performing certain procedures. **NEVER** remove pressure sensing tubes from the Control Board without depressurizing the air-dryer first, or **damage to the Control Board will occur.**

**CAUTION!**

Do not test the Humitter with an ohm meter or apply any DC voltage. This will render the humitter defective.

**WARNING!**

High Noise. Puregas air-dryers are meant to be installed in an unattended area.

**CAUTION!**

Observe precautions for handling **Electrostatic Sensitive Devices.**

**IMPORTANT!**

Performing procedures not described in this User's Guide or installing components not supplied by PUREGAS is **NOT RECOMMENDED AND MAY VOID THE WARRANTY.**

13.3 Air-dryer Won't Power ON

Possible Cause	Check	Corrective Action
Circuit Breaker(s) in OFF position	Verify all three (3) Circuit Breakers are in ON position (section 8.3)	Move all three (3) Circuit Breakers to ON position (section 8.3)
No incoming voltage to air-dryer	Measure incoming voltage (section 9.4)	Troubleshoot facility power supply to air-dryer

13.4 Display Screen Not Functioning

Possible Cause	Check	Corrective Action
Ribbon cable unplugged	Verify that the ribbon cable running from the Control Board to the Display Screen is properly connected at both ends (see section 11.1 for Control Board and Display Screen locations)	Plug in ribbon cable to Control Board and Display Screen (see section 11.1 for Control Board and Display Screen locations)
Defective Display Board	Garbled or no readout with ribbon cable properly connected.	Replace Display Board (section 11.1)

13.5 High Outlet Pressure Alarm

Possible Cause	Check	Corrective Action
Outlet Pressure set too high	Verify Outlet Pressure (OUTP) reading (section 8.4.5.1)	Adjust Outlet Pressure Regulator (section 8.14)
High Outlet Pressure Alarm set point too low	Verify High Outlet Pressure Alarm set point (section 8.8)	Raise High Outlet Pressure Alarm set point (section 8.8)

13.6 Can't Create a High Pressure Alarm

Possible Cause	Check	Corrective Action
Defective Outlet Pressure Regulator	Verify that the Outlet Pressure Regulator can be adjusted (section 8.14)	Replace Outlet Pressure Regulator if unable to adjust pressure (section 11.2)
High Outlet Pressure Alarm set point higher than default setting of 12.0 PSI	Verify High Outlet Pressure Alarm set point (section 8.8)	Adjust Outlet Pressure Regulator so that Outlet Pressure (OUTP) reading climbs over verified set point (section 9.14)
Defective Control Board	Verify that the Outlet Pressure (OUTP) reading is higher than the High Outlet Pressure Alarm set point (above)	Replace Control Board (section 11.1) if Outlet Pressure (OUTP) reading is over verified High Outlet Pressure Alarm set point for more than 1 minute and fails to create an alarm.

13.7 Low Outlet Pressure Alarm

Possible Cause	Check	Corrective Action
Outlet Pressure set too low	Verify Outlet Pressure (OUTP) reading (section 8.4.5.1)	Adjust Outlet Pressure Regulator (section 8.14)
High Flow condition	Verify Flow Rate (FLOW) reading is not higher than expected (section 8.4.5.1)	Troubleshoot High Flow condition (section 13.9)
Air Leak	Test fittings and hoses for leaks(section 9.16)	Reconnect or replace bad fitting / hose
Low Outlet Pressure Alarm set point too high	Verify Low Outlet Pressure Alarm set point (section 8.8)	Lower the Low Outlet Pressure Alarm set point (section 8.8)

13.8 Can't Create a Low Pressure Alarm

Possible Cause	Check	Corrective Action
Defective Outlet Pressure Regulator	Verify that the Outlet Pressure Regulator can be adjusted (section 8.14)	Replace Outlet Pressure Regulator if unable to adjust pressure (section 11.2)
Low Outlet Pressure Alarm set point lower than default setting of 6.5 PSI	Verify Low Outlet Pressure Alarm set point (section 8.8)	Adjust Outlet Pressure Regulator so that Outlet Pressure (OUTP) reading drops below verified set point (section 9.15)
Defective Control Board	Verify that the Outlet Pressure (OUTP) reading is lower than the Low Outlet Pressure Alarm set point (above)	Replace Control Board (section 11.1) if Outlet Pressure (OUTP) reading is under verified Low Outlet Pressure Alarm set point for more than 1 minute and fails to create an alarm.

13.9 High Flow Rate Alarm

Possible Cause	Check	Corrective Action
Air leak in downstream cable outside of dryer	Verify Flow Rate (FLOW) reading is not higher than expected (section 8.4.5.1)	Fix downstream problem
Air leak inside of dryer	Test fittings and hoses for leaks (section 9.16)	Reconnect or replace bad fitting / hose
High Flow Alarm set point too low	Verify High Flow Alarm set point (section 8.8)	Raise High Flow Alarm set point (section 8.8)

13.10 High Cabinet Temperature Alarm

Possible Cause	Check	Corrective Action
Fan Failure	Verify both fans are running (section 9.9)	Check for loose fan wiring (section 14.1) Replace defective fan (section 11.2)
High Ambient Temperature	Verify temperature of location is 40°-85°F.	Lower ambient temperature of location

13.11 High Humidity



CAUTION!

Do not test the Humitter with an ohm meter or apply any DC voltage. This will render the humitter defective.

Possible Cause	Check	Corrective Action
Low System Pressure	Verify System Pressure (section 8.12)	Adjust System Pressure to 50 PSI (section 8.12)
Low Flow Rate	Verify Flow Rate (FLOW) reading is low (section 8.4.5.1)	Increase flow by creating an artificial leak outside of the air-dryer
High Humidity Alarm set point too low	Verify High Humidity Alarm set point (section 9.13) If Flow Rate is low, allowing a higher alarm set point (up to 10%) will allow dryer to run within acceptable levels.	Raise High Humidity Alarm set point (section 9.13) Over 10% not recommended
Heatless Dryer not cycling between towers	Verify consistent Heatless Dryer cycling (section 9.6)	Troubleshoot Inconsistent Heatless Dryer Cycling condition (section 13.20)
Defective Control Board	Unplug Humitter from Control Board (see section 11.1 for Control Board location) Humidity reading should drop to 0%	If Humidity did not drop to 0%, replace Control Board (section 11.1)
Defective Humitter	Turn Dryer OFF . Remove and unplug Humitters (section 9.13.4 & 9.13.5) Swap humitters between System 1 and System 2 to see if Humidity condition follows.	If condition followed humitter, replace humitter (section 11.3)

13.12 Can't Create a High Humidity Alarm / Shutdown

These troubleshooting steps assume that the Humitter is removed from the Humidity Block during the *Testing Humidity Alarm and System Shutdown* (section 9.13) procedures.

Possible Cause	Check	Corrective Action
Humitter Cable disconnected	Verify that Humitter cable is connected through to the Control Board	Connect Humitter cable
Defective Humitter	Verify that Humidity reading fails to climb higher than 15% or creates sporadic readings	Replace Humitter (section 11.3)
Defective Control Board	Verify that Humidity reading is over 15% for more than 1 minute	Replace Control Board if no alarm is created and system does not shut down (section 11.1)

13.13 Compressor Doesn't Operate

Possible Cause	Check	Corrective Action
Defective compressor	Measure voltage to compressor (section 9.3)	If voltage is between 210 – 230 VAC, replace compressor (section 11.4) or send it in for repair (section 12.)
Insufficient power to compressor	Measure voltage to compressor (section 9.3)	If voltage is present, but less than 210 VAC, engage Boost Transformer (section 8.15)
No power to compressor	Measure voltage to compressor (section 9.3)	If voltage is not present or fluctuates, continue to next Possible Cause
Defective Solid-State Relay	Measure voltages at Solid State Relay (section 9.5)	If measurements are bad, replace Solid State Relay (section 11.1)
System is in Shutdown state	On the Display Panel, verify that neither System is in Shutdown state	Press the RESET Button

13.14 Compressor Won't Build Pressure

Possible Cause	Check	Corrective Action
Low System Pressure	Verify System Pressure (section 8.12)	Adjust System Pressure to 50 PSI (section 8.12)
Defective Unloader Valve	Test Unloader Valve operation (section 9.7) If this is continuously flowing high amounts of air, the Unloader Valve is defective.	Replace Unloader Valve (section 11.3)
Leak in air system	Check all hoses and fittings between compressor and Air Tank for air leaks (section 9.16)	Connect, tighten, or replace leaking component

13.15 Compressor Excessive AMP Draw

Possible Cause	Check	Corrective Action
Restriction in air line	Remove Discharge Hose from compressor (see section 11.4 for location of hose) Re-measure Compressor AMP Draw (section 9.2)	If measurement is below 4.0 amps, trace hoses from compressor to Unloader Valve looking for restrictions or kinks
Compressor failing	Remove Discharge Hose from compressor (see section 11.4 for location of hose) Re-measure Compressor AMP Draw (section 9.2)	If measurement is still above 4.0 amps, replace compressor (section 11.4) or send it in for repair (section 12.)

13.16 High Compressor Temperature

Possible Cause	Check	Corrective Action
Fan Failure	Verify both fans are running (section 9.9)	Check for loose fan wiring (section 14.1) Replace defective fan (section 11.2)
High Ambient Temperature	Verify temperature of dryer operating location. Recommended ambient temperature is 40°-85°F.	Lower ambient temperature of dryer operating location
Dirty Air Intake Filter	Remove Air Intake Filter and check to see if Compressor temperature reading returns to normal range	Replace Air Intake Filter included in the Six Month Maintenance Kit (section 11.6)

13.17 Compressor Excessive Run Time Alarm

Possible Cause	Check	Corrective Action
Low System Pressure	Verify System Pressure (section 8.12)	Adjust System Pressure to 50 PSI (section 8.12)
High Flow condition	Verify Flow Rate (FLOW) reading is not higher than expected (section 8.4.5.1)	Troubleshoot High Flow condition (section 13.9)
Defective Unloader Valve	Test Unloader Valve operation (section 9.7) If this is continuously flowing high amounts of air, the Unloader Valve is defective.	Replace Unloader Valve (section 11.3)
Defective Heatless Dryer Solenoid Valve	Verify consistent Heatless Dryer cycling (section 9.6) If either side is continuously flowing high amounts of air, the Solenoid Valve is defective.	Replace Solenoid Valves included in the 8,000 Hour Maintenance Kit (section 11.6)
Defective Solid State Relay	Measure voltages at Solid State Relay (section 9.5)	If measurements are bad, replace Solid State Relay (section 11.1)

13.18 Can't Create a Compressor Excessive Run Time Alarm

Possible Cause	Check	Corrective Action
Compressor Excessive Run Time Alarm set point higher than the default of 3:00 minutes	Verify Excessive Compressor Run Time Alarm set point (section 9.12)	Allow the compressor to run longer than the verified set point (section 9.12)
Defective Control Board	Verify that the compressor has run longer than the verified Excessive Compressor Run Time Alarm set point (above)	Replace Control Board (section 11.1) if the compressor runs longer than the verified Excessive Compressor Run Time Alarm set point by 1 minute or more and fails to create an alarm.

13.19 Compressor Rapid ON/OFF Cycling

Possible Cause	Check	Corrective Action
Defective Solid State Relay	Measure voltages at Solid State Relay (section 9.5)	If measurements are bad, replace Solid State Relay (section 11.1)
Defective Control Board	Measure voltages at Solid State Relay (section 9.5)	If measurements are good, replace Control Board (section 11.1)

13.20 Inconsistent Heatless Dryer Cycling

Possible Cause	Check	Corrective Action
Defective Solenoid Valve	Measure voltage going to the Heatless Dryer Solenoid Valves (section 9.8)	If 106 VDC IS present, replace Solenoid Valves included in the 8,000 Hour Maintenance Kit (section 11.6)
Defective Cycle Timer	Measure voltage going to the Heatless Dryer Solenoid Valves (section 9.8)	If 106 VDC IS NOT present, replace the Cycle Timer (section 11.3)

13.21 Contacting Altec AIR Technical Support

Please read the *Before You Call Altec AIR* (section 13.1)

Once you have exhausted all of the potential problems and solutions covered in the *Troubleshooting Your Dryer* section, and you still require further assistance to correct a problem, contact RFS Technical Support:

(800) 521-5351 (**option 1**)

Have the following information available:

Trouble Ticket # (if following-up on a previous call): _____

Technician Name: _____ **Phone #:** _____

Model #: **BD8400W** **Serial #:** _____

Company Name: _____ **Location Name:** _____

City: _____ **State:** _____

14. Appendix

14.1 Wiring Diagram

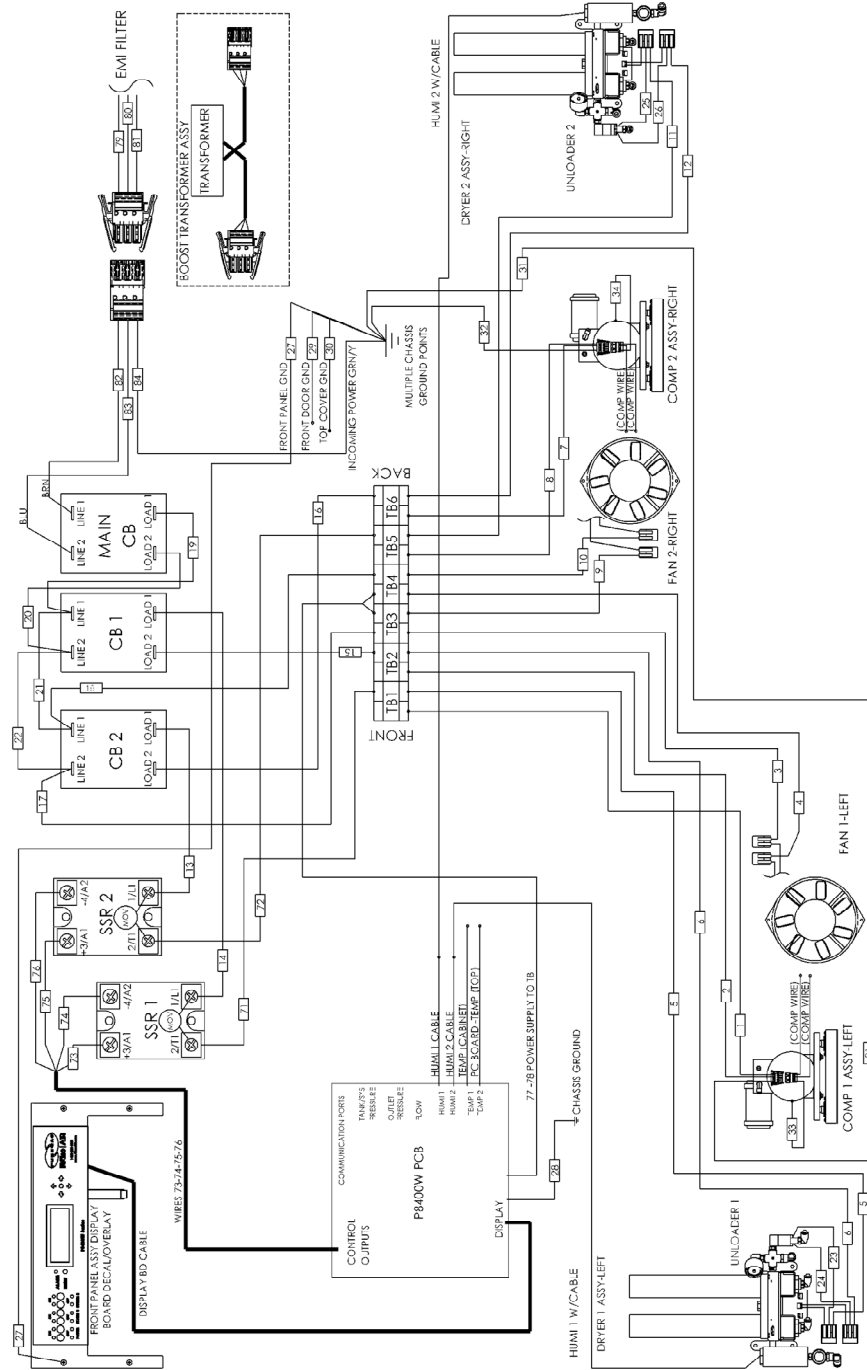

14.2 Set Point Limits and Defaults

14.2.1 System Adjustments

Description	Minimum Value	Maximum Value	Default Value	Unit of Measurement
System Pressures	48.0	52.0	50.0	PSI
Static Pressure	17.0	17.0	17.0	PSI
Outlet Pressure	1.0	15.0	10.0	PSI

14.2.2 Alarm Set Points

Description	Minimum Value	Maximum Value	Default Value	Unit of Measurement	Shutdown
High Flow Alarm	100	40,000	4,500	SCFD	
High Outlet Pressure Alarm	0.2	20.0	12.0	PSI	
Low Outlet Pressure Alarm	.1	19.9	6.5	PSI	
High Humidity Alarm	3.0	15.0	10.0	%	YES
Excessive Compressor Run Time Alarm	1:00	59:59	3:00	Minutes : Seconds	

14.2.3 System Operations

Description	ON Value	OFF Value	Default Value	Unit of Measurement
Compressor	20.0	50.0		PSI
High Cabinet Temperature Alarm			120.0	Deg F
High Compressor Temperature Alarm			120.0	Deg F
Compressor Total Run Time Reset			8,000	Hours

14.2.4 SNMP Parameters

Device Configuration Information

Device ID	Alphanumeric (Defined by Customer)
Device Model	Alphanumeric (Factory Preset)
Device Firmware Version	Numeric (Factory Preset)
Current Date/Time	Numeric (mm/dd/yy hh:mm)
IP Address	Numeric (xxx.xxx.xxx.xxx)
Subnet Mask	Numeric (xxx.xxx.xxx.xxx)
Gateway Address	Numeric (xxx.xxx.xxx.xxx)
SNMP Trap Server Address	Numeric (xxx.xxx.xxx.xxx)

SNMP Read Community String (also sets SNMP Trap Community String)	Alphanumeric (6-14 digits, Default = "public")
SNMP Write Community	Alphanumeric
Status Readings (Read-Only)	
Outlet Pressure Reading	Numeric (PSI)
Tank Pressure Reading	Numeric (PSI)
System 1 Humidity Reading	Numeric (%)
System 2 Humidity Reading	Numeric (%)
System 1 Duty Cycle Reading	Numeric (%)
System 2 Duty Cycle Reading	Numeric (%)
Flow Reading	Numeric (SCFD)
Cabinet Temperature Reading	Numeric (DEG F)
Compressor 1 Total Run Time Reading	Numeric (Hours)
Compressor 2 Total Run Time Reading	Numeric (Hours)
Compressor 1 Last Run Time Reading	Numeric (Seconds)
Compressor 2 Last Run Time Reading	Numeric (Seconds)
System 1 Status	ON / SHUTDOWN / STANDBY
System 2 Status	ON / SHUTDOWN / STANDBY
Compressor 1 Status	ON / OFF
Compressor 2 Status	ON / OFF
Alarm Readings (Read-Only)	
High Flow Alarm	OK / Alarm
High Outlet Pressure Alarm	OK / Alarm
Low Outlet Pressure Alarm	OK / Alarm
High Humidity System 1 Alarm	OK / Alarm
High Humidity System 2 Alarm	OK / Alarm
High Cabinet Temperature Alarm	OK / Alarm
Compressor 1 Last Run Time Alarm	OK / Alarm
Compressor 2 Last Run Time Alarm	OK / Alarm
Maintenance Required System 1 Alarm	OK / Alarm
Maintenance Required System 2 Alarm	OK / Alarm
Total Alarm	OK / Alarm
Configuration Settings (Read-Write)	
High Flow Alarm Threshold	Numeric (SCFD)
High Outlet Pressure Alarm Threshold	Numeric (PSI)
Low Outlet Pressure Alarm Threshold	Numeric (PSI)
High Humidity Alarm Threshold	Numeric (%)
High Duty Cycle Alarm Threshold	Numeric (%)
Compressor Last Run Time Alarm Threshold	Numeric (Seconds)
Reset Compressor Total Run Time Reading	Numeric (Hours)
Start Up Delay Time	Numeric (Seconds)
Alarm Delay (1 Minute)	ON / OFF
Alarm Traps Sent to SNMP Server	
High Flow	
High Outlet Pressure	
Low Outlet Pressure	
High Humidity	
High Duty Cycle	
High Cabinet Temperature	
Compressor Last Run Time	
Maintenance Required	

15. Limited Warranty Agreement

RFS products carry a two (2) year warranty against defective workmanship and material. This period starts at date of shipment. Not included are the components subject to normal replacement during a year's operating time.

No claims for labor in replacing defective parts or for consequential damages will be allowed. Replacement parts will be invoiced in the regular way, with invoices subject to adjustment after the parts claimed defective are examined at our factory. In addition, no material or parts will be accepted at our factory for in-warranty repairs or credit without previous authorization from RFS.

Responsibility for damages incurred in transit will be borne by the user and the user in turn should file any damage claim against the carrier. All warranty items are F.O.B. Broomfield, Colorado. Freight charges are the responsibility of the user.

This warranty shall not apply to any RFS product which shall have been repaired or altered in any way by anyone other than RFS or authorized personnel so as to affect, in our judgment, its proper functioning or reliability, neither will it apply to any product which has been subject to misuse, negligence, or accident. The installation of unauthorized non RFS parts will void the warranty on those RFS products.

Registration Reminder

If you haven't already done so, please take a moment to register your RFS BD8400W Air-dryer. **Registering is necessary to activate this Limited Warranty on your product.** Once you register, you are eligible to receive free technical support, as well as updates concerning your RFS products.

See Section 7. for details on Registering Your Dryer.

16. Contacting RFS

16.1 General / Sales

Radio Frequency Systems

<https://info.rfsworld.com/contact-us>

16.2 Service

Altec AIR, LLC

226A Commerce Street

Broomfield, Colorado 80020

parts@AltecAIR.com

(800) 521-5351

Fax – (303) 657-2205

16.3 Technical Support

Radio Frequency Systems

ApplicationsEngineering@rfsworld.com

(800) 659-1880

Fax – (203) 634-2057

Altec AIR, LLC

226A Commerce Street

Broomfield, Colorado 80020

support@AltecAIR.com

(800) 521-5351

Fax – (303) 657-2205

DON'T FORGET TO REGISTER YOUR DRYER!

See Section 7. for details on Registering Your Dryer.

